

Number:



# Buki di Ehercicio IV

aña 3

**Produccion**

Grupo di MEDILES:  
Aurita Meenhorst-Arends  
Clarice Holman  
Diana Marchena-Martes  
Nita Gomez-Rasmijn  
Saskia Dirksz  
Shartine Geerman-Rodriguez

**Redaccion**

Maritza Petrochi-Everon

**Ilustracion**

Daniëlle Schothorst

**Logo**

Stan Kuipert

**Lay-out**

Nita Gomez-Rasmijn

**Colaboracion**

Emma School  
Scol Caiquetio  
Scol Paso pa Futuro  
Cilia Pablo, Elsa Wernet, Gino Vrolijk, Sheila Werleman, Zeld Steenen

**Edicion**

Departamento di Enseñansa Aruba  
Seccion Desaroyo di Curiculo

Prome edicion

ISBN 978-99904-699-2

© 2015 Departamento di Enseñansa Aruba

Tur derecho reserva. No ta permiti pa reproduci ningun parti di e metodo aki, di ningun forma ni pa ningun medio, sin autorisacion previo y por escrito di e editor.  
Exception: pa uzo na scol.

# Buki di Ehercicio IV

aña 3



**Mona Lisa**

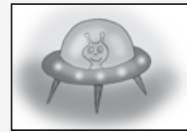

**Zum den tempo**



**Trotaglobo**

## **MEDILES**

Metodo di Lenga pa Enseñansa Special

Seccion Desaroyo di Curiculo

Departamento di Enseñansa Aruba

2015

# Contenido

1. Mona Lisa	5
2. Zum den tempo	13
3. Trotaglobo	29

# Mona Lisa



Mini tema B

# Mona Lisa



graffiti



palet di pintura



tubo di verf



stift

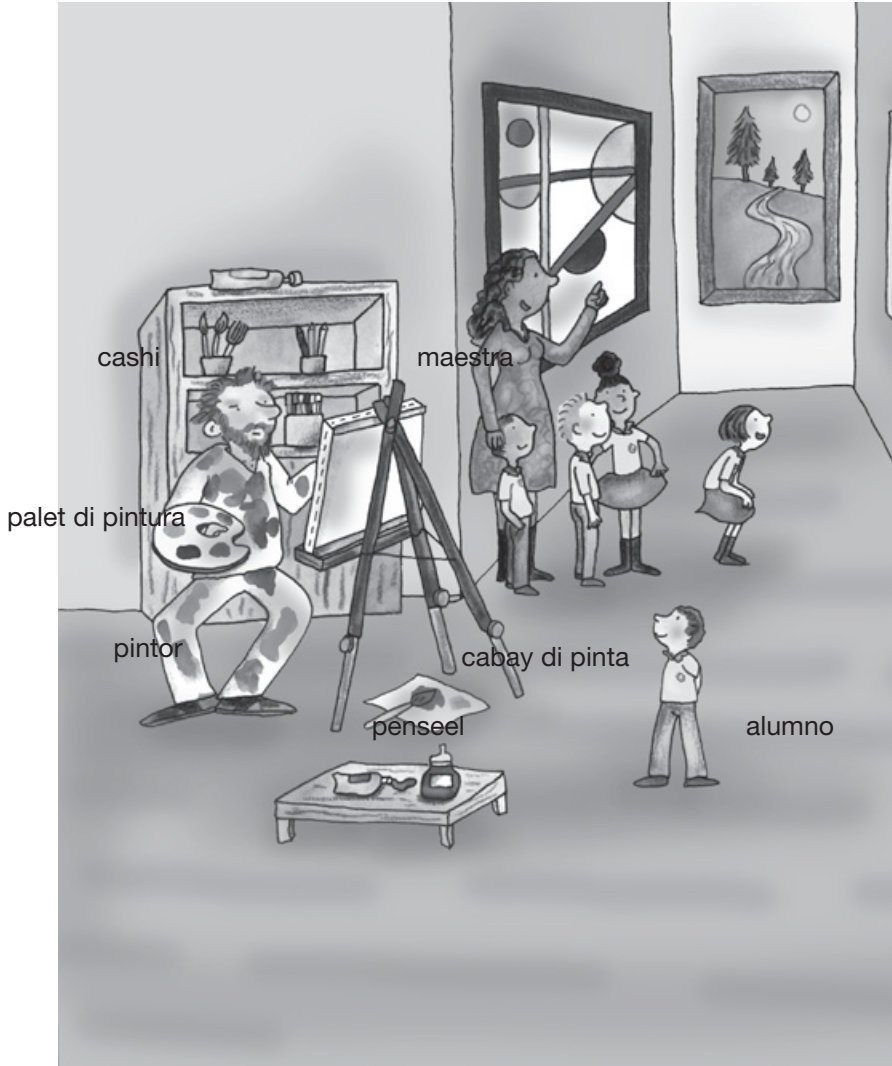

cashì

maestra

palet di pintura

pintor

cabay di pinta

penseel

alumno



Wiel di color



potlood di kleur



krijt di color



potret Mona Lisa



kleur segun number



ekipo/material  
pa airbrush



vingerverf



pochi di inkt



maletin cu  
material pa verf



waterverf



...







...



...

## Kico e palabra kiermen?

1. Lesa e palabra, busca e frase cu ta bisa kico e palabra kiermen.
2. Wak cua ta e plachi cu ta pas cu e palabra y e frase.
3. Hala liña di e palabra pa e frase y despues pa e plachi corecto.

• Mona Lisa <input type="checkbox"/>	<input type="checkbox"/> polis a detene esun cu a horta <input type="checkbox"/>	<input type="checkbox"/> 
• sonrisa <input type="checkbox"/>	<input type="checkbox"/> un aparato pa filma <input type="checkbox"/>	<input type="checkbox"/> 
• camara <input type="checkbox"/>	<input type="checkbox"/> algo pa tapa cara <input type="checkbox"/>	<input type="checkbox"/> 
• gara <input type="checkbox"/>	<input type="checkbox"/> hari sin saca zonido <input type="checkbox"/>	<input type="checkbox"/> 
• mascarada <input type="checkbox"/>	<input type="checkbox"/> un pintura famoso <input type="checkbox"/>	<input type="checkbox"/> 





...



...



...

# Kico bo ta sinti ora bo wak e cuadra?

1. Wak e cuadra.
2. Con e ta laga bo sinti?
3. Pinta den e cara con bo ta sinti, ☹ of ☺.
4. Skirbi den un frase cortico con bo ta sinti.

Ehempel:

☺ E cachonan ta tutu.
 

---



---



potret



---



---



naturalesa inmobil



---



---



abstracto



---



---



paisahe



---



---



...



...



...

# Diesunchi

A. Lesa e poema di 11 palabra.

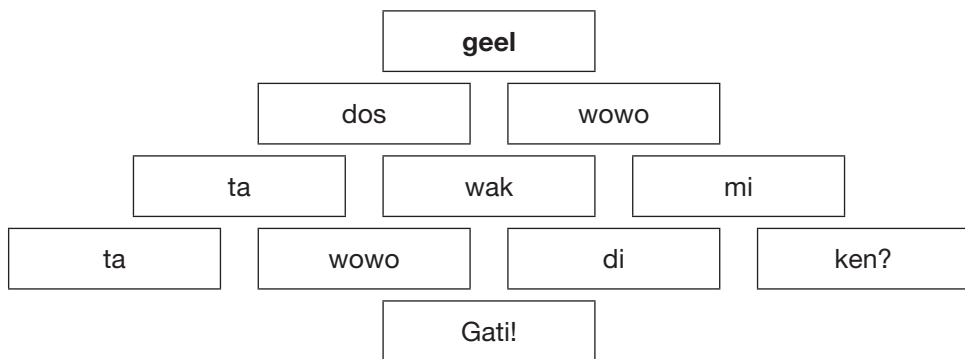

B. 1. Marca e ronchi di e titulo cu ta scoge.

**cora**,  **bunita**,  **color**,  **dos**,  **pensa un titulo**.

2. Skirbi bo poesia di 11 palabra.

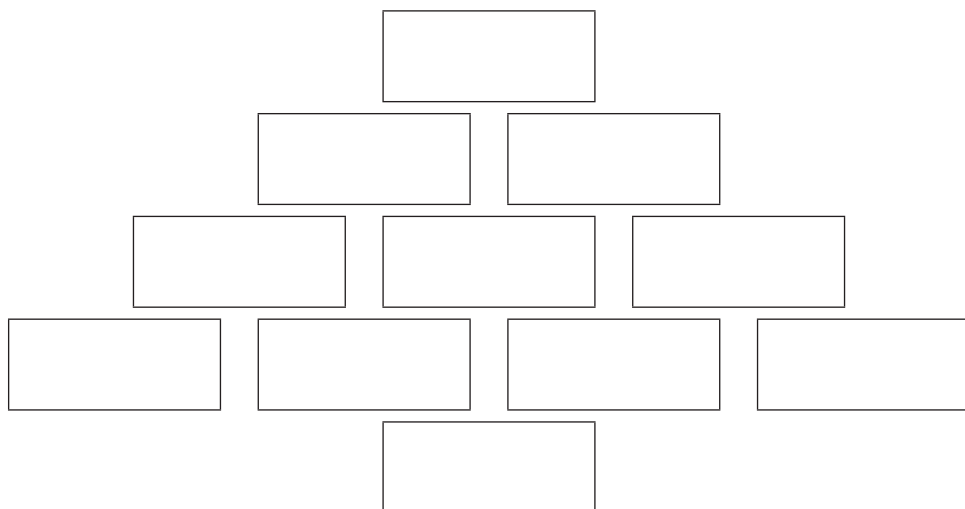



...



...



...

## Traha bo carchi di invitacion

1. E lider ta lesa loke tin skirbi riba pagina 29 den BA II.
2. E otro muchanan ta haci loke e lider ta bisa.
3. Practica den grupo con ta haci e invitacion.



Bo ta invita

? .....

 .....

 .....

 .....

 .....



# Zum den tempo

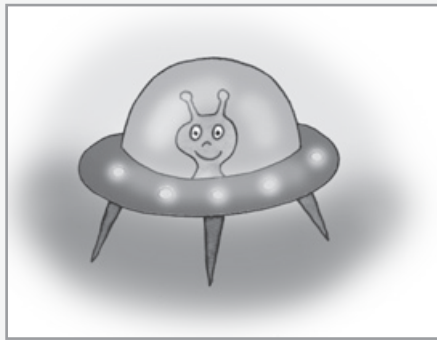

## Tema 9

presente

Zum den tempo

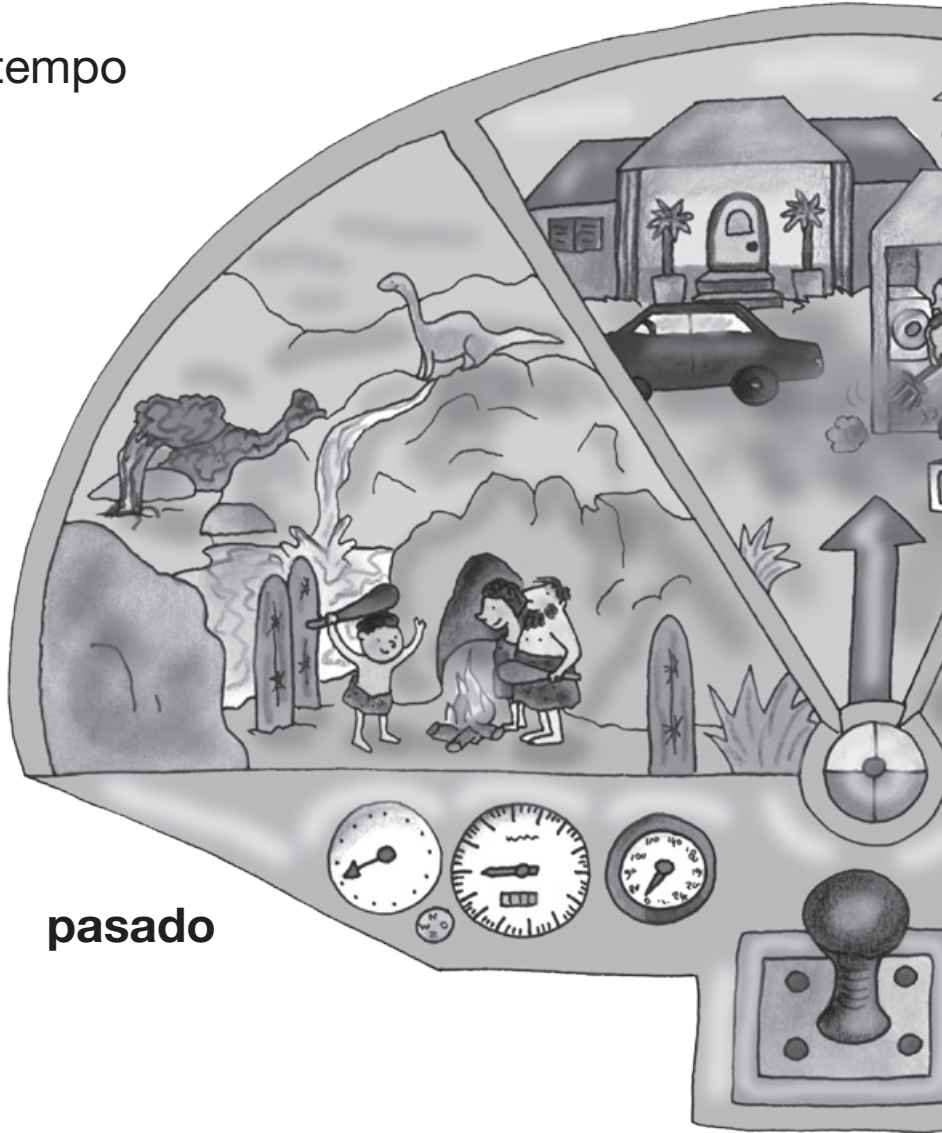

pasado



holoshi di santo



holoshi



stoof



cuminda na candela

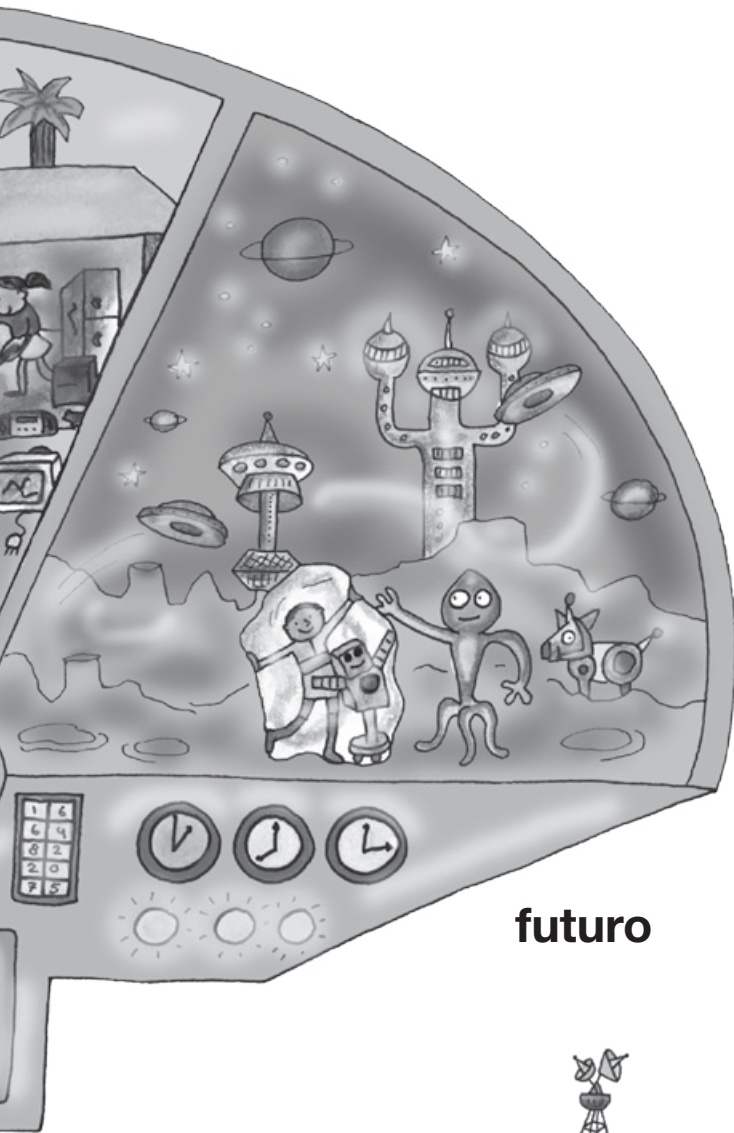

## futuro

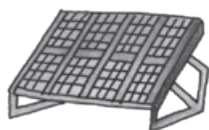

panel di solo



antena

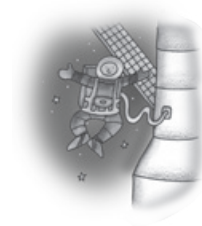

astronaut wanta na space station



satellite dish



telefon di cas



yamada via computer  
(skype)



molina di biento



...



...







...

A. Wak e plachi. Esaki a pasa na cuminsamento, memey of na final?



- cuminsamento
- memey
- final

B. 1. Lesa y marca un cruz den e hoki cu tin e frase cu ta cuadra cu e expresion.

<p>◆ Karin ta topa cu un santanero den cura.</p> <p>Karin kier core, pero <b>su pia ta bira pisa</b>.</p>	<p></p> <p><input type="checkbox"/> Karin su pia a bira gordo.</p> <p><input type="checkbox"/> Karin no por move.</p>
<p>◆ Papa no ta mira e santanero.</p> <p></p> <p><b>Den un frega di wowo</b> e santanero a somenta. E no ta den cura mas.</p>	<p><input type="checkbox"/> Hopi lihe e santanero a somenta.</p> <p><input type="checkbox"/> E santanero su wowo ta core awa.</p>
<p>◆ Papa ta wak si e santanero a bay den e baki di Wela.</p> <p></p> <p>E baki ta <b>mas bieu cu Musalem</b>.</p> <p>Hopi tempo pasa Wela a haya e baki ey regalo.</p>	<p><input type="checkbox"/> E baki ta limpi. </p> <p><input type="checkbox"/> E baki ta hopi bieu.</p>

2. Abo mes pensa cua expresion ta pas.

- Papa ta wak e santanero den e baki di Wela.  Ora Papa wak bon, no ta un santanero pero un cascabel. Papa kier core bay pero e no por move.

Papa su .....





...



...



...

# Storia: Cuminda tin

1. Lesa e storia.

## Cuminda tin

Un musca ta busca cuminda.  
 Su hala a pega den un forki.  
 E no por bula bon mas.  
 Poco poco e musca ta bati su hala.  
 Porfin e musca ta yega pafo.  
 Bam! E musca ta riba tera den cura.  
 Un dori ta cana pasa.  
 Mmm ... un musca, e dori ta pensa.  
 “Kico a pasa? Bo no por bula mas?  
 Bin mi ta hiba bo”, e dori ta bisa.  
 Ata un warawara ta bula.  
 Ha ... un dori y un musca, e ta pensa.



forki



dori



musca



warawara

2. Skirbi un final pa e storia: *Cuminda tin*.

.....

.....

.....

.....

.....

.....

.....

.....

.....

.....

3. Bo ta kere cu e dori di berdad lo hiba e musca? Dicon?

.....

.....



...

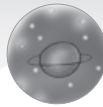

...



...

# Kico lo por pasa?

## A. Lesa e texto hunto.

Scoge palabra for di e lista di palabra y skirbie na e luga indica.

Henter ora Linda y Marco ta hunga hunto.

Nan ta ..... amigo.

Linda a pasa man pa e celular di su mama.

Ta poco tempo ey mama a haya e celular aki.

Linda y Marco ta hunga cu e celular ..... di mama.

Mama a paga hopi cen pa e celular.

E ta un celular .....

Ora di bay cas, Marco a bay cas cu e celular ..... di mama.

Linda no ta gusta kico Marco a haci.

Con Marco cu Linda por bira ..... amigo bek?

Marco ta bin bek cu e celular ..... di mama.

E ta pidi Linda despensa cu el a bay cu e celular.

Awor si Linda tin un cara .....

Linda y Marco a bolbe bira ..... amigo.

- contento
- caro
- nobo
- bon

## B. Lesa e texto. Contesta e pregunta.

1. Den e cura di Karin tin un santanero.

Awe e santanero a sali pa busca cuminda.

Un warawara ta bula pasa y ta mira e santanero.

E warawara ta hari so. E ta bolbe pasa riba e cura di Karin.

Kico ta bay pasa? .....

.....

2. Yopi ta gusta come bolo.

Mama ta lubida di warda e bolo ora e bay sosega.

Yopi so ta keda den sala.

Kico lo por pasa? .....

.....



...



...



...

# Bo a scucha e storia bon?

A. E storia ta tur bruha.

Pone e storia den bon secuencia door di numera e frasenan.

**Storia:** *Den e nave di Zula*

1 Karin y Ungabunga ta wanta duro na e basora.  
Nan no sa unda nan ta bay.

\_\_ E robot di Zula ta bay busca Karin pafo di e nave.

\_\_ Nan ta core cu Zula den su nave pa conoce Marsola.

4 Ay mi mama, Karin a cay pafo di e nave ora el a bay w.c.

\_\_ Ta ora pa bay cas bek.

\_\_ Ata nan a yega den e nave di Zula.

B. Lesa e frasenan akibou.

Skirbi den bo mesun palabranan kico Zula ta bisa.

Zula a bisa: “E basora ta boso yabi. Corda bon, boso mester keda tene e basora. No lubida!”

.....

.....

.....

.....

.....



...



...



...

# Ken ta bisa kico?

- A. 1. Lesa e texto.
- 2. Pone punto dobel (:) y comia (“ ”) na e luga corecto.
- 3. Caba cu e frasenan cu falta.

### Texto:

- ◆ Karin ta cansa y e tin gana di come.  
E ta bisa: “Mama mi tin hamber.”  
Mama ta contesta Tin cuminda riba mesa.

Karin ta bisa .....

- ◆ Cubata ta bula pa loco.  
Zula ta bisa: Cubata para keto!  
Cubata no ta para keto.

Zula ta bisa .....

- ◆ Ta hopi calor.  
Dino y Cubata ta den cas.  
Mama ta bisa Sali pafol!  
Dino y Cubata ta contesta: Solo ta kima.

Mama ta bisa .....

- B. Describi cada plachi.  
Skirbi dos frase pa cada plachi.



1. ....

2. ....



1. ....

2. ....



1. ....

2. ....



...



...



...

# Kico ta pas cu ken?

1. Lesa texto: *Mucha morocho y robot morocho* (BA II, pagina 34).
2. Yena kico ta pas cu mucha morocho y kico ta pas cu robot morocho.
3. Yena memey kico ta pas cu tur dos.



Mucha morocho

tin cabey

.....

.....

.....

.....

.....

.....

.....

.....



Robot morocho

no tin cabey

.....

.....

.....

.....

.....

.....

.....

.....

Tur dos

.....

.....

.....

.....

.....

.....

.....

.....



...



...



...

# Kico ta di ken?

A. Wak e obheto bon, di ken e ta?

Hala un liña di e obheto pa e plachi di Ungabunga of Karin.



piedra



telefon portatil



herment



dinosaurio



short



saya cu blusa



candela

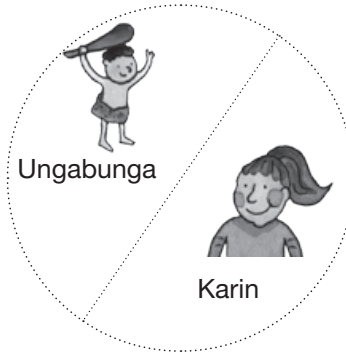

Ungabunga

Karin



dinosaurio



bais



chicoti



laptop



flanel



camara

B. Skirbi di ken e obhetonan ta.



Ungabunga



Karin

.....  
.....  
.....  
.....  
.....  
.....

.....  
.....  
.....  
.....  
.....  
.....



...



...







...

# Ken ta bisa kico?

- A. 1. Marca signo di lesa den e texto.
- 2. Scoge un personahe di e storia di strip y lesa kico e ta bisa.

<p>di unda bo ta bin y ta kico bo tin</p>	<p>ta di cas mi ta bin y ta un basora mi tin ki mascota esey ta</p>
 <p>Ungabunga</p>	 <p>Karin</p> 
<p>un Dino cu ta come sin fin</p>	<p>mi mascota ta un lora cu ta canta tur ora</p>
 <p>Ungabunga</p> 	  <p>Karin</p>

- B. Wak kico tin pinta. Kico Ungabunga y Karin ta bisa otro?  
Skirbi den e balon di texto. Corda uza signo di lesa.

<p>.....</p> <p>.....</p> <p>.....</p>	<p>.....</p> <p>.....</p> <p>.....</p>
 <p>Ungabunga</p> 	  <p>Karin</p>



...



...



...

# Expresion

A. Lesa e texto. Marca un strepi bou di cada expresion cu bo lesa.

### Karin ta busca Yuyucu

Karin ta yora.  
 Su lora Yuyucu a sali for di cura.  
 Karin ta bay busca Yuyucu.  
 Karin ta wak den cura di hende.   
 E ta wak Yuyucu ta yanga bay na cas di un cacho.

  
 Karin sa cu e cacho ey ta morde hende.

  
 Karin ta purba core, pero su pia ta bira pisa.

  
 Wrrrruuuuuff! Wrrrruuuuuff! E cacho ta sali for di su cas.

  
 Den un frega di wowo Yuyucu ta pafo di e cura.

  
 Un poco mas y e cacho ta morde Yuyucu.

B. Papia/combersa riba e nificacion di cada expresion.  
 Skirbi e nificacion di cada expresion den bo mesun palabranan.

- .....  
 .....  
 .....
- .....  
 .....  
 .....





...

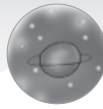

...



...

## Reclamo

1. Lesa e texto.
2. Pensa bon con mester haci e reclamo.
3. Practica con ta haci e reclamo.

◆ Rino y su dos amigonan ta sinta na mesa ta come.  
E amigonan ta combersa di sacamento y di wc.  
Esun ta conta e otro con el a saca mahos ayera.  
Rino no ta gusta cu su amigonan ta papia tocante di sacamento ora e ta come.

- ***Kico Rino ta bisa su amigonan y con?***

◆ Tur ora Rosi ta tenta Zina.  
E ta bisa Zina cu su tas ta mahos.  
Zina ta yora ora Rosi bisa esey.  
Awe Rosi ta wak Zina den su cara y e ta bisa:  
“Zina, bo tin cara di payaso!”  
Awe Zina no ta yora, pero e ta bay bisa Rosi pa e no tenta mas.

- ***Kico Zina ta bisa Rosi y con?***

◆ Tur ora Mili ta bisti e sapato di su ruman Elca, sin pidi.  
Elca no ta gusta esaki.  
Ata! Awe Mili ta bisti e sapato di Elca.  
Elca ta bay bisa Mili pa e no uza su sapato mas.

- ***Kico Elca ta bisa Mili y con?***

◆ Karin a paga pa un celular nobo.  
Karin ta uza e celular pa yama su amiga.  
O o! E no por yama na e celular.  
E ta cunsumi.  
E celular no ta bon.  
Karin ta hiba e celular bek pa e bendedo.

- ***Kico Karin ta bisa e bendedo y con?***



...



...



...

# Bisa kico e ta y di ken

1. Nombra e obheto.
2. Di ken e ta? Skirbi e palabra banda di dje.



chicoti



cacho robot



planeta



lora



tata



instrumento di nave



cueba



dinosaurio



herment



telefon portatil



nave



basora



bais



Ungabunga

.....

.....

.....



Karin

.....

.....

.....



Zula

.....

.....

.....



...



...



...

- A. • Wak e palabra cu ta marca diki.
- Busca e sinonimo di e palabra diki marca.
- Skirbi e frase di nobo, uzando e sinonimo for di e lista di palabra.

tempo pasa – celular – hala – wanta

- Zula a **move** su nave na banda.

Zula .....

- Dino ta un animal di **antes**.

Dino .....

- Karin tin su basora bon **gara**.

Karin .....

- Papa a lubida su **telefon** riba mesa.

Papa .....

B. Traha frase cu e palabra.

- nave .....

.....

- planeta .....

.....

- robot .....

.....



# Trotaglobo

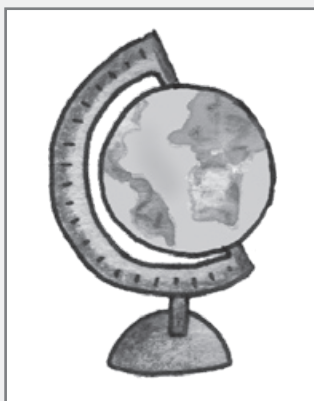

Tema 10

# Trotaglobo



teleferico



balon di aire



iglo



eskimo



ski



bayena



ijsbeer



gletsjer



cacho di lama



watalval

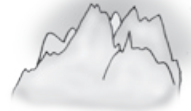

sero di ijs





canoa



GPS



pagay



piramid



desierto



camel



bahul di tesoro



oasis



momia



avion



tent



indjan Yanomami



hamaca



farao

candela

campamento



...



...



...

## *Pregunta di e storia: Trotaglobo*

- A. 1. Lesa e pregunta.  
 2. Combersa, delibera kico ta bay contesta.  
 3. Un mucha ta skirbi e contesta.

- Ken ta den e balon? .....
- Unda nan ta bay? .....
- Kico a pasa ora e balon ta riba e campamento di indjan? .....
- Con e piloto a salba nan? .....

- B. Abo mes traha 3 pregunta tocante e storia: **Trotaglobo**.  
 Scoge for di e lista di palabra:

Kico? – Ken? – Con? – Unda? – Dicon? – Ki ora? – Cuanto?

1. ....
2. ....
3. ....





...



...



...

## Skirbi carta

A. Con abo lo a skirbi e carta pa e piloto?

Corda pone signo di lesa si falta. Uza potlood di color.

Aa Bb Cc	.	?	!	:	“ ”
----------	---	---	---	---	-----

.....

.....

.....

.....

.....

.....

.....

.....

.....

.....

B. Kico ta bay den cada tas?

1. Marca un cruz door di e obheto cu no ta pas.

2. Bisa dicon bo ta pensa asina.

**tas pa lama**



**tas pa scol**

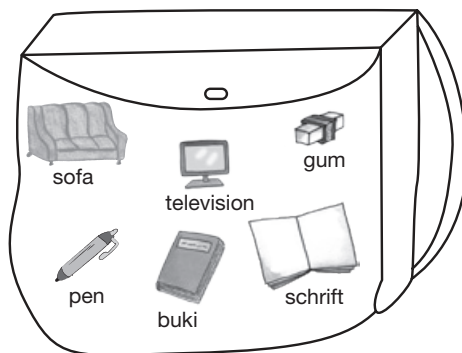





...



...



...

### 1. Haya e palabra door di **salta** letter.

Cuminsa cu e hoki cu tin e ♥ aden y sigui e flecha.  
 Skirbi e letter cu tin den e hoki, riba e prome liña.  
 Cada biaha salta un hoki y skirbi e letter cu tin den e hoki.  
 Kico e ta? Skirbi e nomber un bes mas riba liña #2.

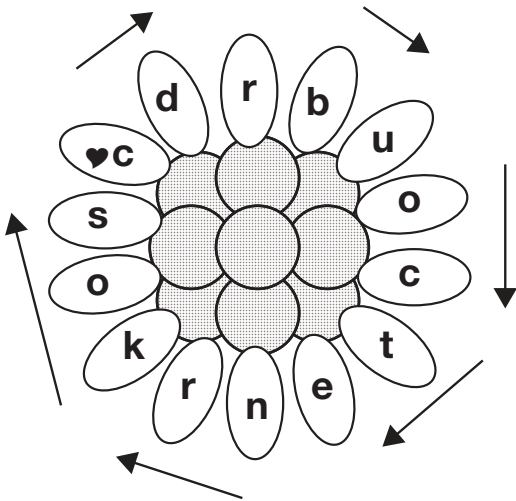

#1

#2

### 2. Haya e palabra door di **sigui** e flecha.

Cuminsa cu e hoki cu tin e ♥ aden.  
 Skirbi e letter cu tin den e hoki riba e prome liña.  
 Sigui e flecha y cada biaha skirbi e letter cu tin den e hoki.  
 Kico e ta? Skirbi e nomber un biaha mas riba liña #2.

♥ c	o	n	s	a
v	a	b	o	p
f	m	n	t	l

#1

#2



...



...



...

# Hunga cu alfabet!

1. Hala liña pa conecta e puntonan cu otro.  
Cada punto ta un letter di alfabet.
2. Marca e liñanan segun secuencia di alfabet.  
Cuminsa cu letter **a** y caba cu letter **z**.
3. Kico e ta? Pinta mas obheto acerca.

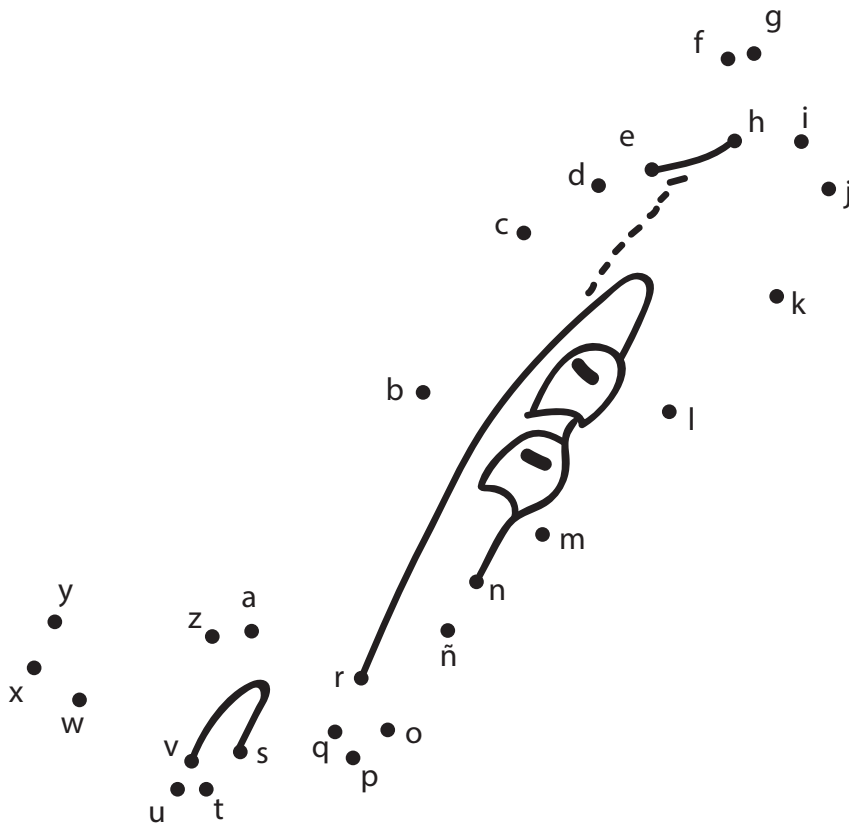



...



...



...

# Hunga cu alfabet

## Diferenciacion:

1. Conecta e liñanan segun secuencia di alfabet.  
Cuminsa cu letter **a** y caba cu letter **z**.
2. Kico e ta? Pinta mas obheto acerca.

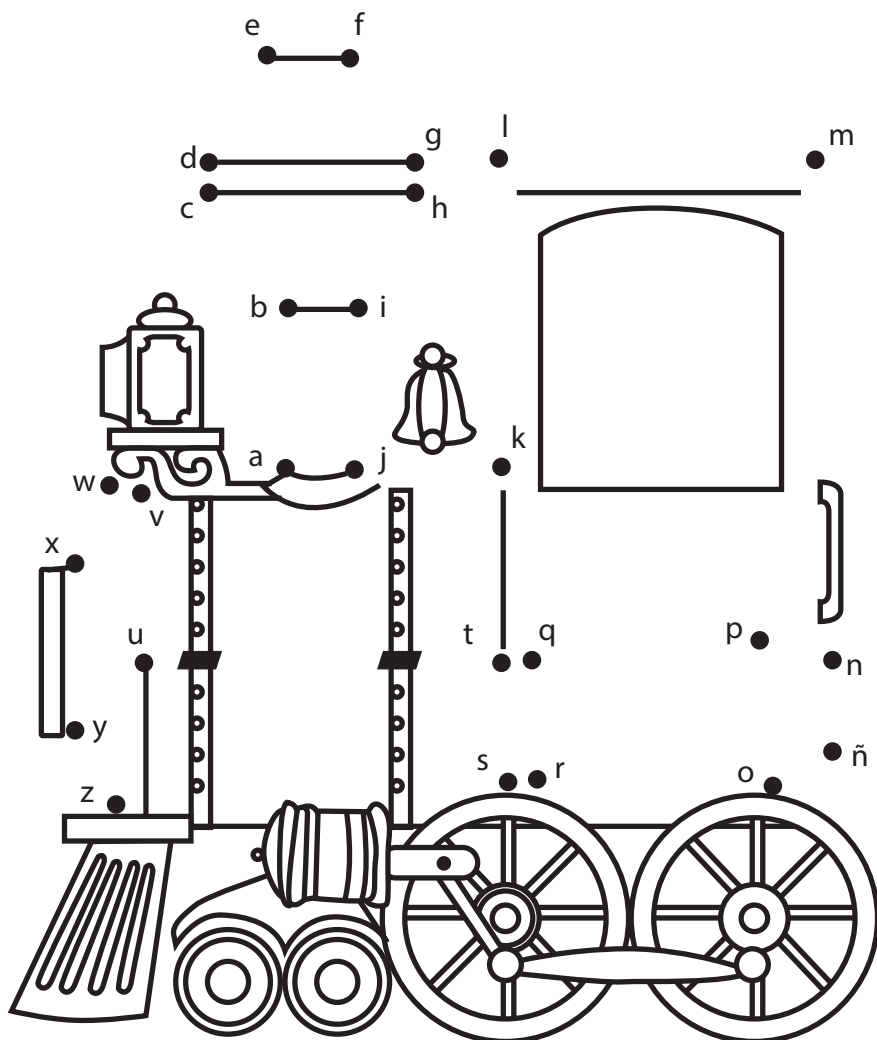



...



...



...

## Storia: *Den teleferico*

- A. 1. Lesa e texto riba pagina 41 di BA II.
2. Contesta e preguntanan.



◆ Unda Elselin y Cody ta bay den e teleferico? .....

.....

◆ Kico a pasa na mita caminda .....

.....



◆ Di berdad e teleferico a keda pega? .....

.....

◆ Dicon si, dicon no? .....

.....

.....

- 
- B. 1. Scoge palabra for di e lista di palabra y traha bo mesun pregunta tocante e texto.
  2. Skirbi e preguntanan.

Kico? – Cua? – Dicon? – Unda? – Cuanto? – Ki ora? – Ken?

1. ....

2. ....



...



...



...

## Hunga cu homonimo

a. Lesa e frasenan.

Cua plachi ta pas cu e frase?

b. Skirbi e number di e frase den hoki di e plachi corecto.

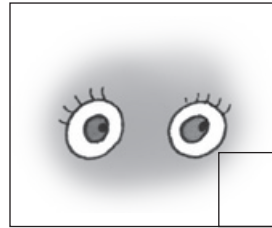
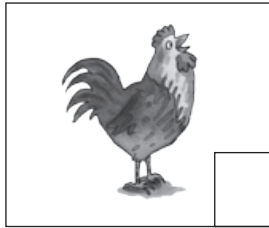
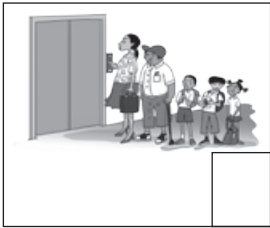

1. Mi **wowo** ta pica di e calor cu ta haci.
2. Cody a subi e **lift** pa bay na e di dos piso di e hotel.
3. E **gay** ta canta pa e lanta tur hende.
4. Madu no por pasa e hilo den e **wowo** di e hangua.
5. Cody no a haya **lift** pa e bay cas.
6. E **gay** a pela su cabey.

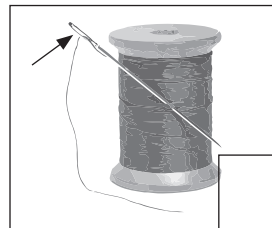
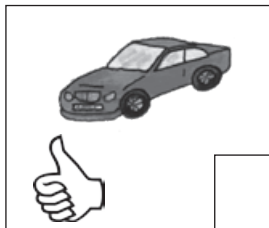



...



...



...

## Hunga cu palabra

A. Wak e plachi. Cua frase ta pas cu e plachi.  
Hala un liña di e plachi pa e frase.



1. **Lora** e regalo aki pa mi.
2. E bala ta **lora** riba caminda.



1. Carlos ta bisti keds di **marca**.
2. Roly tin un **marca** na su cara.



1. Melisa no sa con pa hunga **carta**.
2. Mama ta gusta lesa **carta** cu mi ruman ta manda di Hulanda.



1. E bombero a yega na ora pa **paga** candela.
2. Mi a **paga** bon cen pa e carson ey.

B. 1. Cua palabra no ta pas den e rij?  
Marca un cruz door di e palabra.

- campa – campamento – coredo – campado
- pisca – bula – piscamento – piscado – piscando
- canta – cantante – canto – barido - cantamento
- bari – bula – bulamento – bulado — bulando
- perde – perdedo – movimiento – perdemento

2. Skirbi mas palabra cu ta bin di e palabranan aki.

- come - .....
- cana - .....





...



...



...

## Invitacion pa ...

Les a e carchi di invitacion y contesta pregunta.

**Pa:** Famia Tutu.

*Boso ta cordialmente invita na apertura di e exposicion: 'E tesoro di Farao Tutunpan'*

**Luga:** Museo Famoso.

**Situa na:** Caya Camel 205, Egipto.

**Vestuario:**

- deportivo
- casual/nechi
- formal (tuxedo y shimis largo)

**Ora:** Di 7 or pa 9 or anochi.

**Entrada:** Un sonrisa.

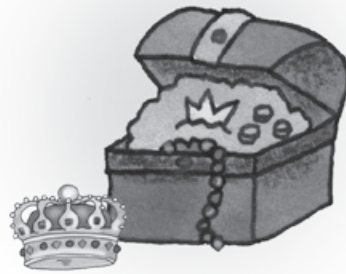

1. Pa ken e carchi di invitacion ta? .....
2. Kico ta e ocasion? .....
3. Con yama e luga unda e ta tuma luga? .....
4. Unda e luga ey ta keda? .....
5. Kico bo ta pensa cu papa y Cody mester bisti? .....
6. Kico bo ta pensa cu mama y Elselin mester bisti? .....
7. Cuanto pa entrada? .....



...



...



...

- A. • Wak e plachi.
- Bisa con e homber y e momia ta bisti.
- Skirbi tres cos di cada un.



**Homber:**

1. ....
2. ....
3. ....

**Momia:**

1. ....
2. ....
3. ....

B. 1. Ban lesa di Ali y su rumannan. Ali ta amigo di Cody.

mi	bo	su	nos	boso	nan
----	----	----	-----	------	-----

2. Scoge di e lista di palabra y yena e frase.

Ali tin dos ruman, Boraca y Cilo.

Ali ta hiba ..... camel pa ..... rumannan wak.  
 Su ruman Boraca ta bisa: "Ali, esey si ta un bunita camel."  
 Boraca y Cilo a gusta e camel hopi. Nan tambe ta bay busca un camel.  
 Boraca y Cilo no tin hopi cen. Nan ta bay busca un camel pa nan dos.

Boraca y Cilo ta hiba ..... camel pa Ali wak.  
 E camel ta pa tur dos core ariba. E camel ta di .....

Ali ta bisa su dos rumannan: "Mi ta gusta ..... camel.  
 ..... camel ta hopi bunita. Awo ..... tur tin camel."



...



...



...

# Hunga cu alfabet secreto

- A. 1. Wak e alfabet secreto riba pagina 43 di BA II.
- 2. Skirbi e palabranan riba e liña. Kico ta e mensahe?

	.....
	.....
	.....
	.....
	.....
	.....
	.....
	.....

B. Abo por traha un palabra cu e alfabet secreto?





## Sugerencia pa reparti e temanan di aña 3 durante aña escolar

tema	titulo	topico	luna
Tema 1	Mucha turista	Turista	Augustus - September
Tema 2	Na careda	EHBO	September - October
Tema 3	Bichi Buki	Literatura	October - November
Tema 4	Campeon Porfin	Deporte	November - December
Mini tema A	Trikitraca	Aña nobo	November - December
Tema 5	Momito	Carnaval	Januari
Tema 6	Don Slip	Cared'i auto	Februari
Tema 7	Binchi Brabo	Superheroe	Februari - Maart
Tema 8	Na_liñ@.com	Telecomunicacion	Maart
Mini tema B	Mona Lisa	Pintamento	April
Tema 9	Zum den tempo	Mashin di tempo	Mei
Tema 10	Trotaglobo	Biahamento	Juni

