

buki di contesta

Conta
cu mi

buki di alumno-schrift di tare

3^a



Departamento di Enseñansa di Aruba

Metodo di matematica pa enseñansa primario

buki di contesta

**Conta
cu mi**

buki di alumno-schrift di tercer



Desarrollado por el Ministerio de Educación de Cuba

1 na scol atrobe.



2 conta loke bo ta wak.

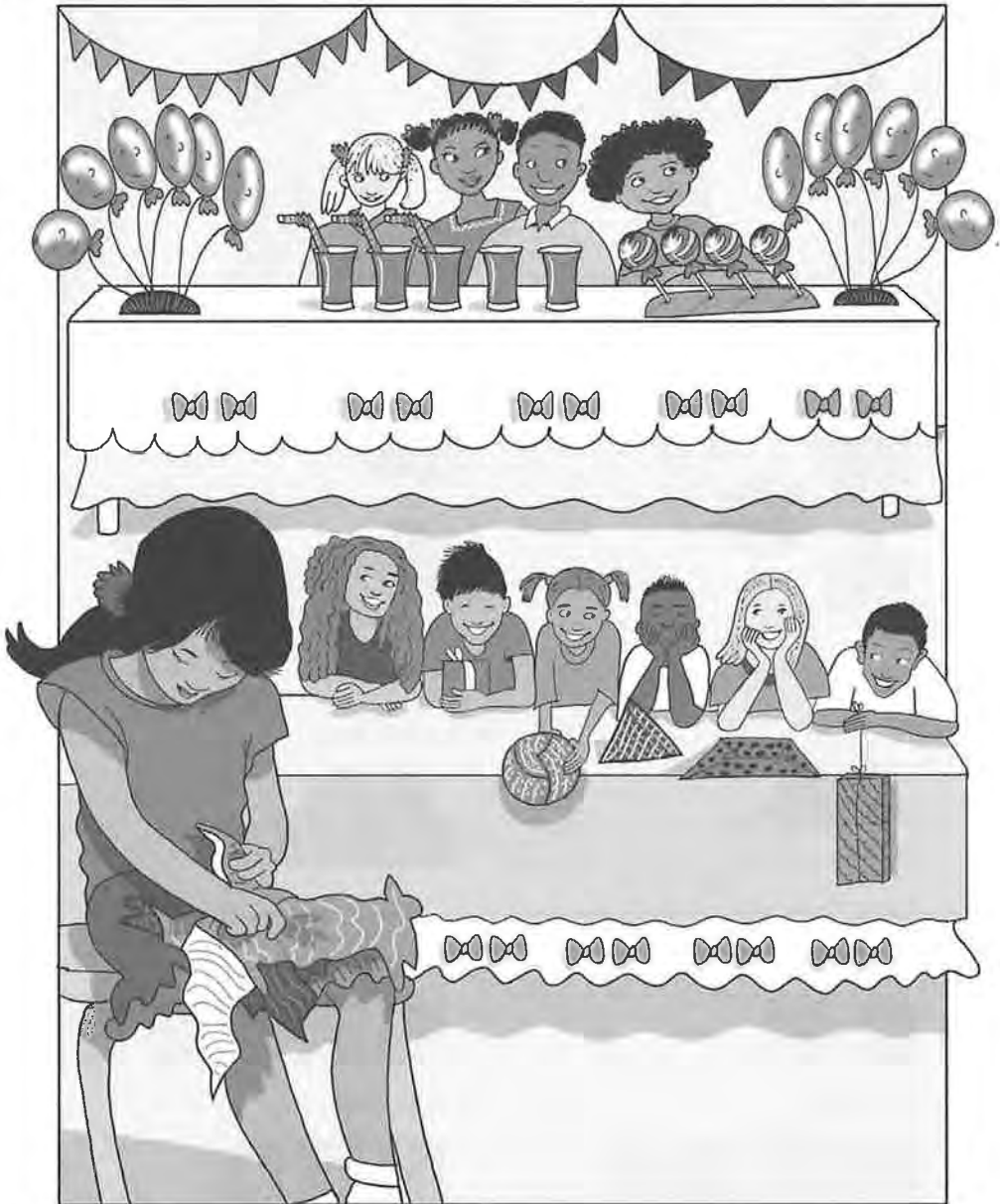

1 kleur e cifranan.



2 kleur.

a kleur 3 regalo.

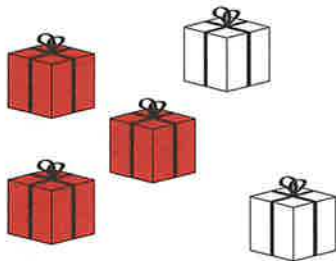

b kleur 4 regalo.

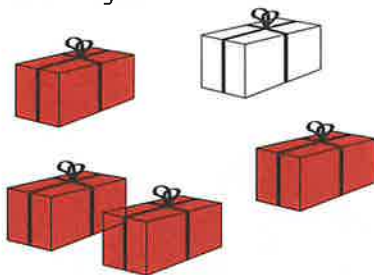

3 kleur.

a kleur 2 regalo.



b kleur 5 regalo.



4 kleur.

a kleur 2 hoki.



b kleur 5 hoki.



c kleur 4 hoki.



d kleur 3 hoki.



5 pinta 1 mas.

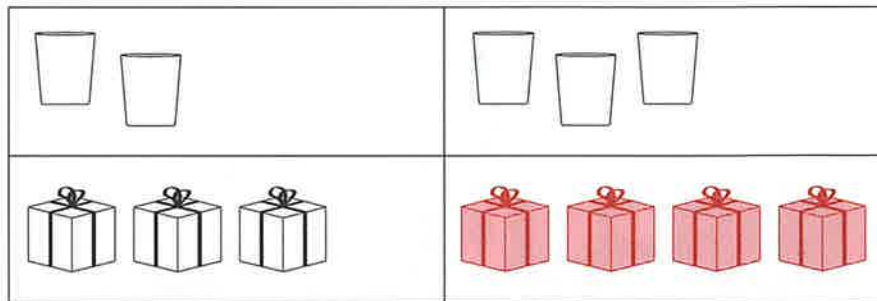

6 pinta 1 menos.

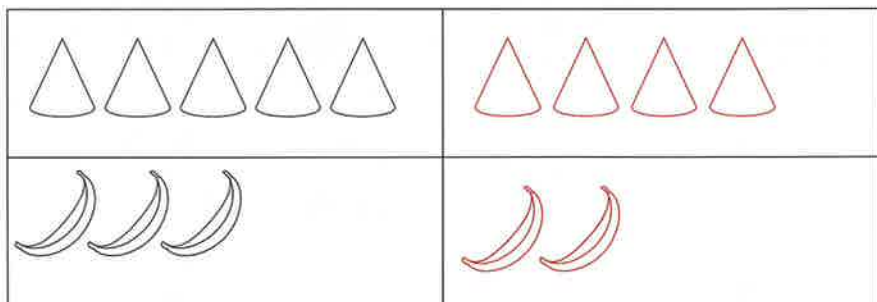

7 pinta mes hopi.

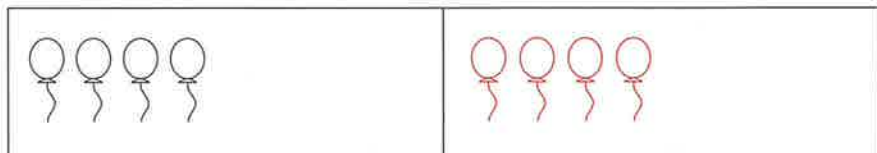

8 pinta 2 mas.

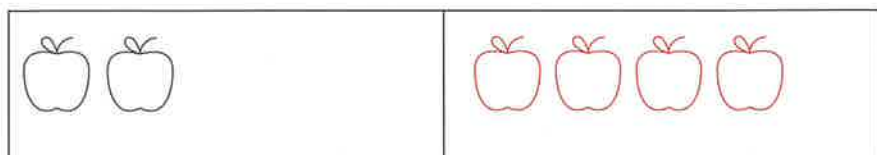

1 nos klas.

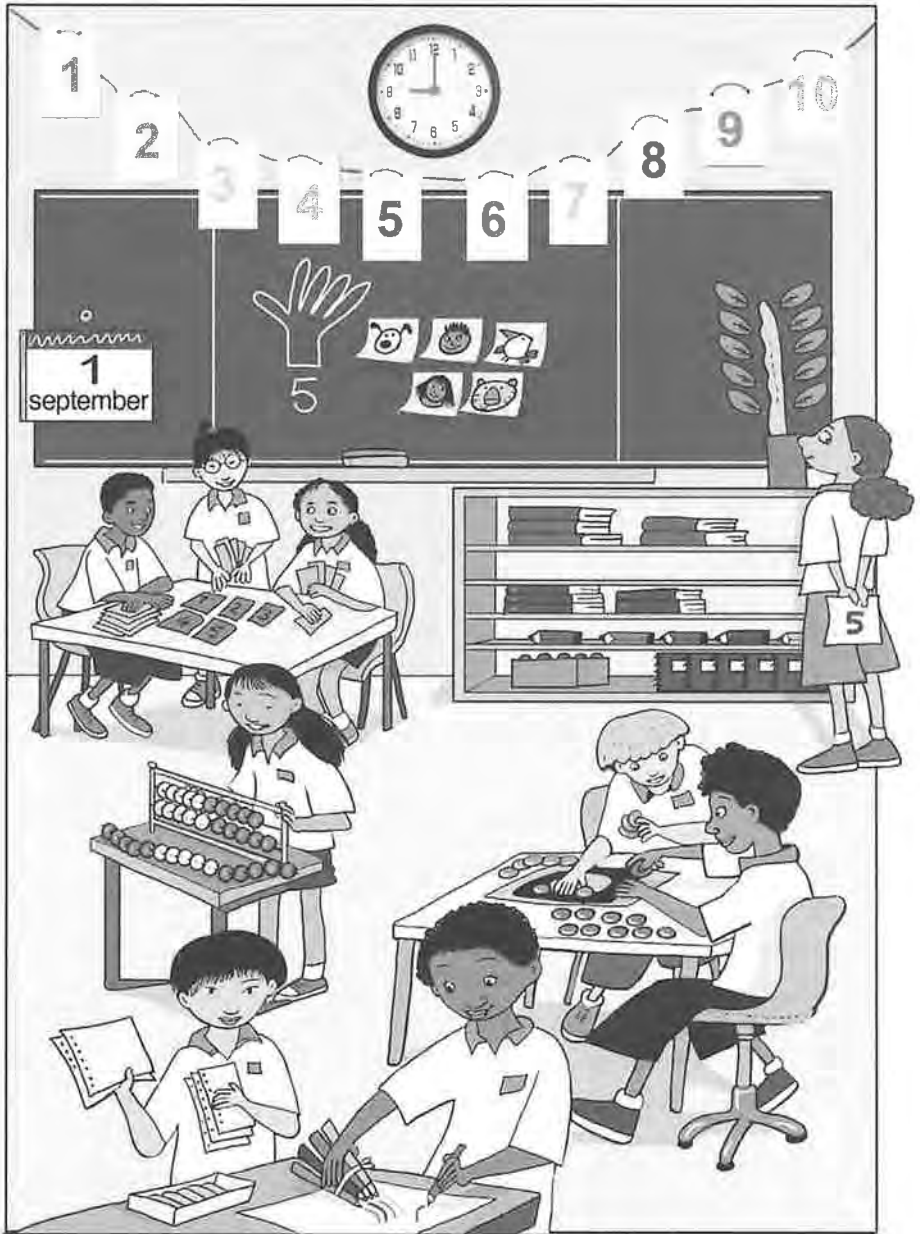

2 pone ficha.

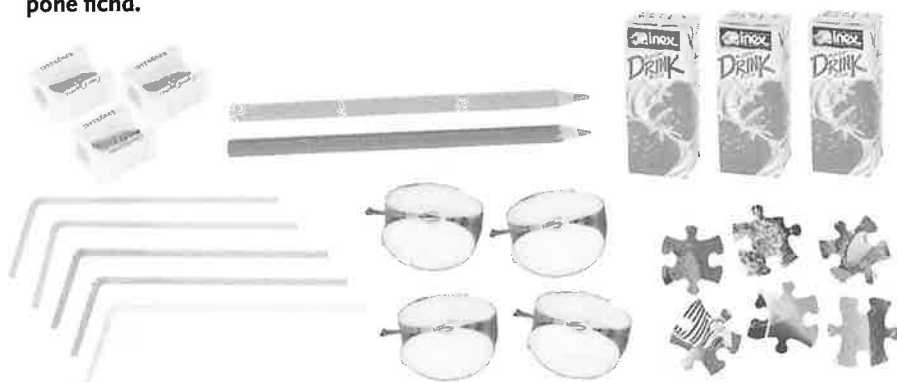

3 busca e number cu ta pas.

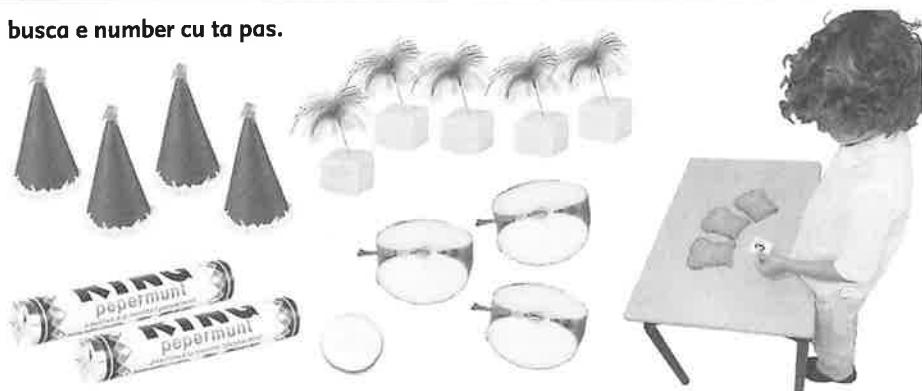

4 conta riba dede.

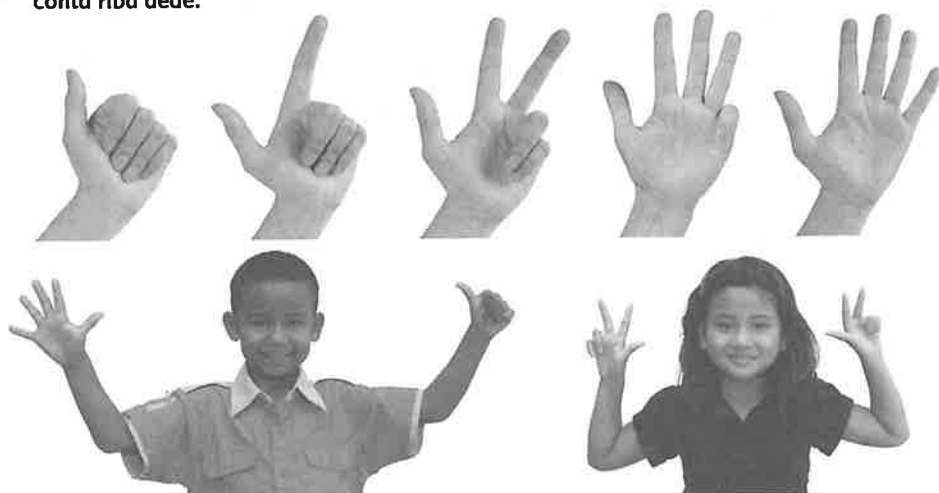

1

conecta cu otro.

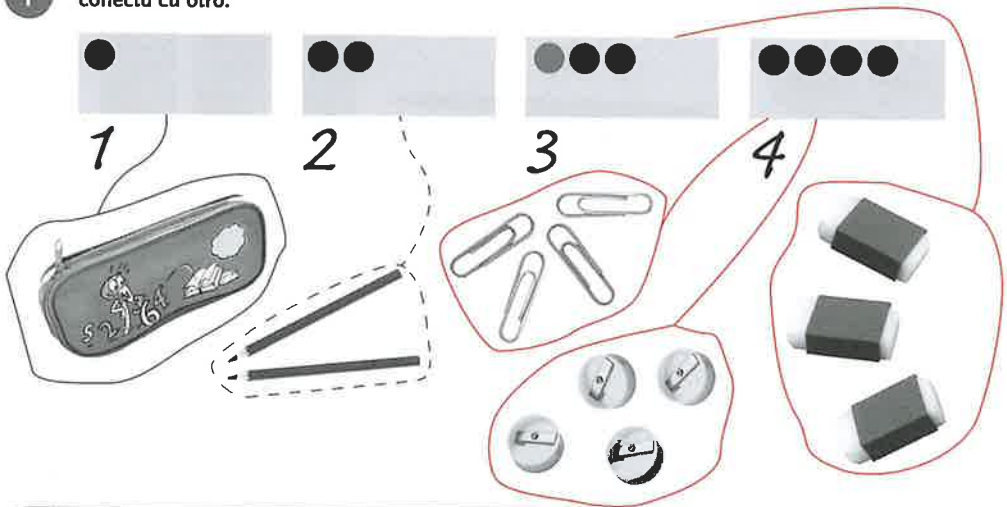

2

traha grupo di 2.

2

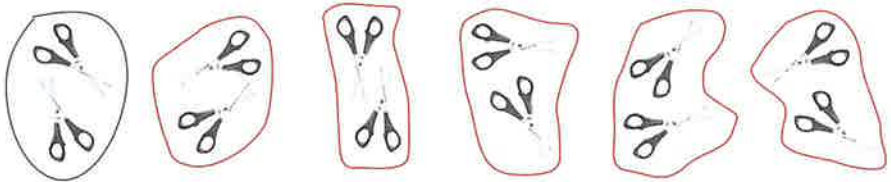

3

traha grupo di 3.

3

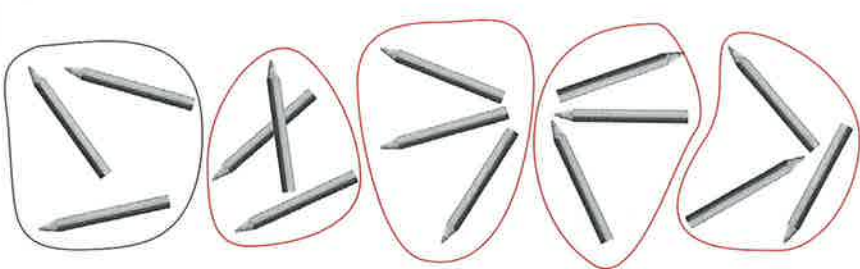

4

traha grupo di 4.

4

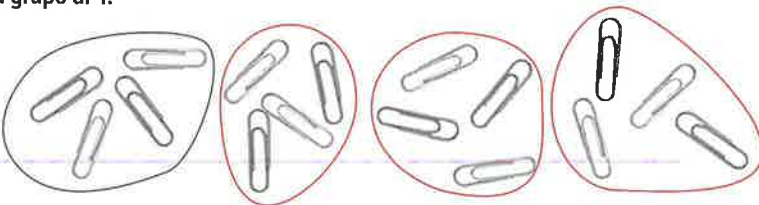

5 conecta cu otro.

5 6 7

6 traha grupo di 3.

7 traha grupo di 4.

8 traha grupo di 5.

5

9 pinta mes hopi.

1 2 3 4 5

1

kleur.

a kleur 4 blaas.



b kleur 2 pechi.

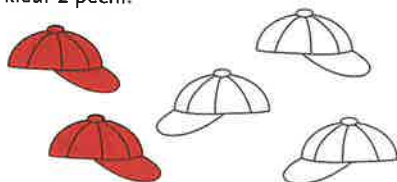

2

pinta 1 mas.

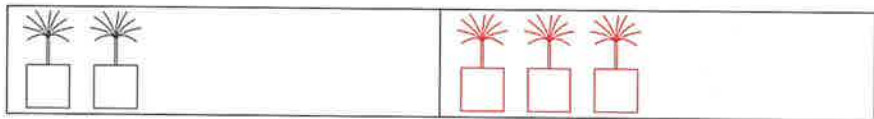

3

pinta 1 menos.

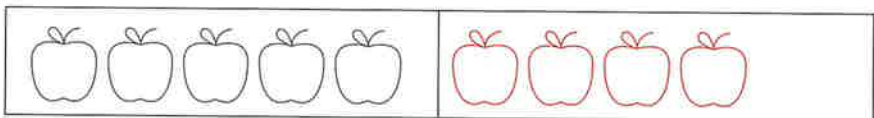

4

pinta mes hopi.

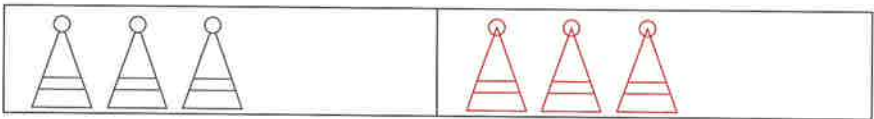

5

traha grupo di 3.

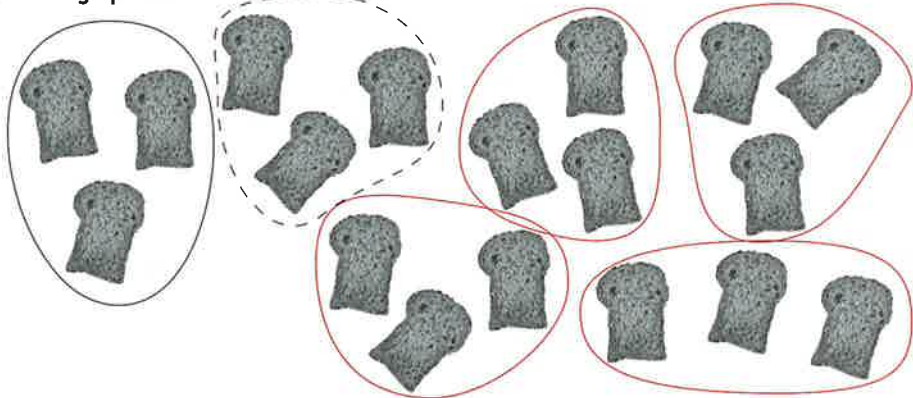

6 traha grupo di 4.

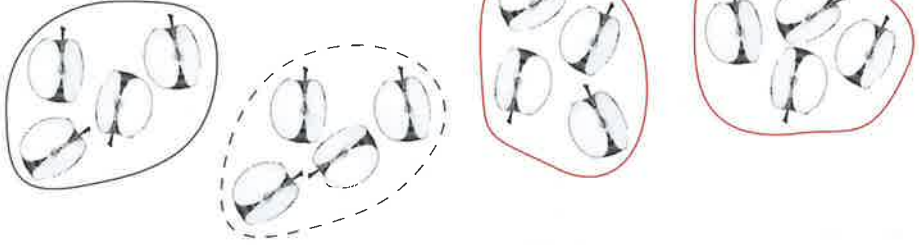

7 traha grupo di 5.

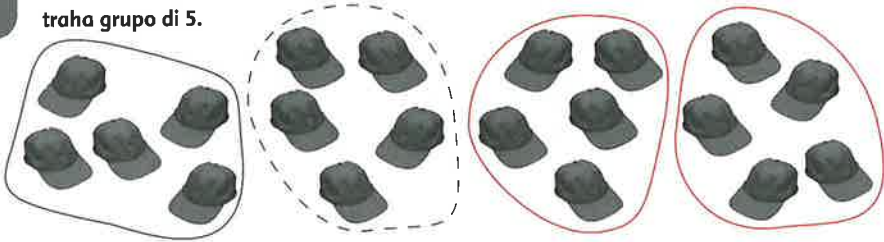

8 pinta 2 mas.

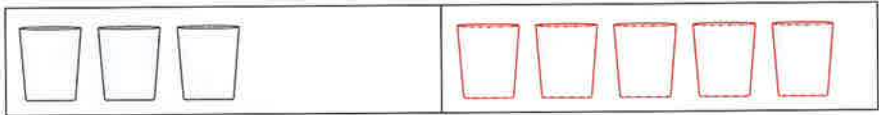

9 pinta mes hopi.

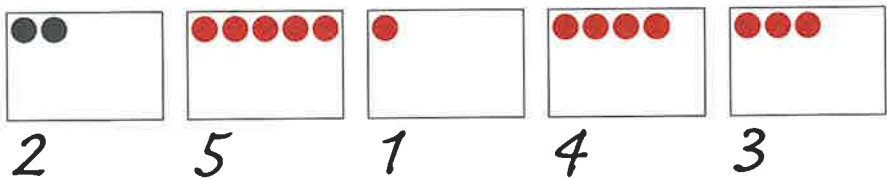

10 conecta cu otro.

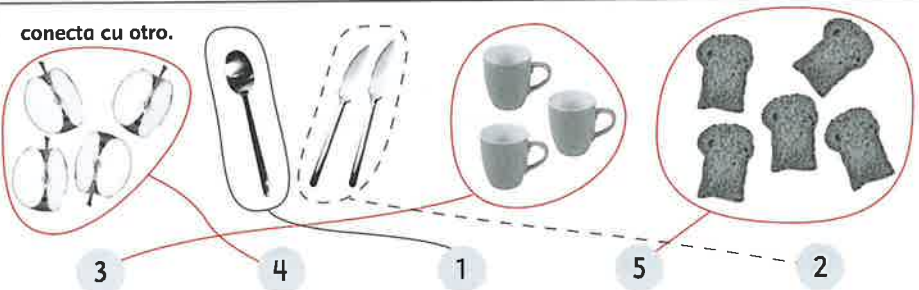

1 den pauze.

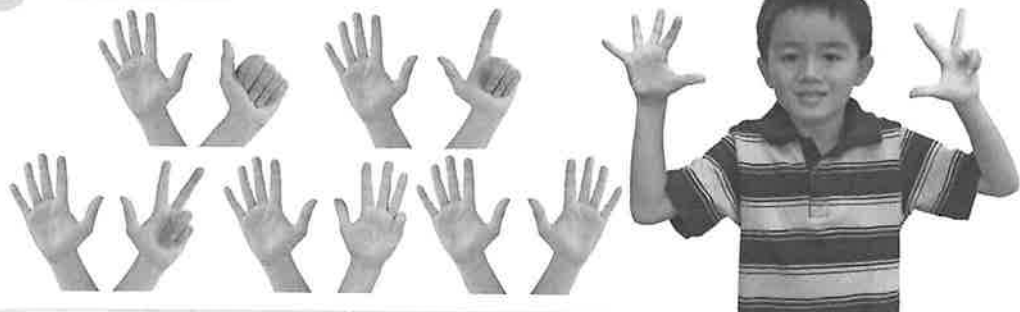
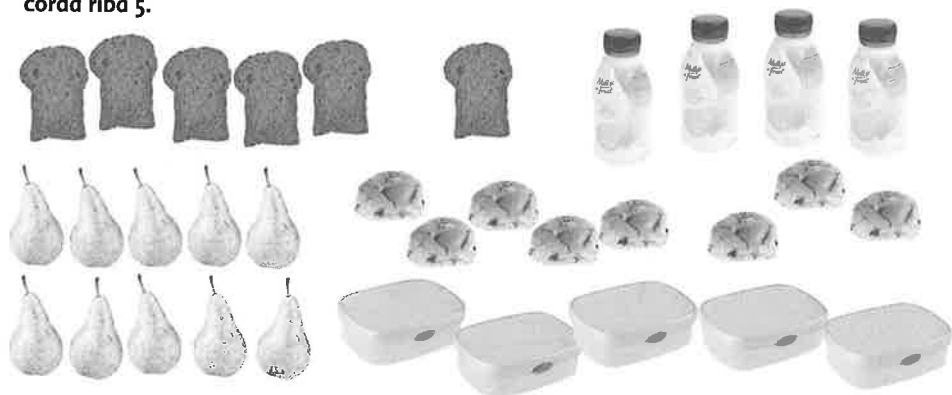

2 conta riba dede.

3 cuanto tin?
corda riba 5.

4 quanto tin?

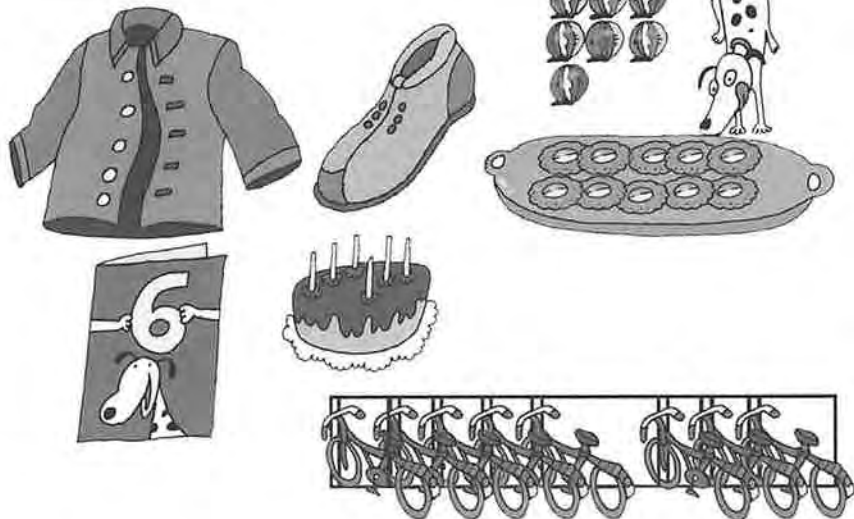

5 busca cua ta pas cu otro.

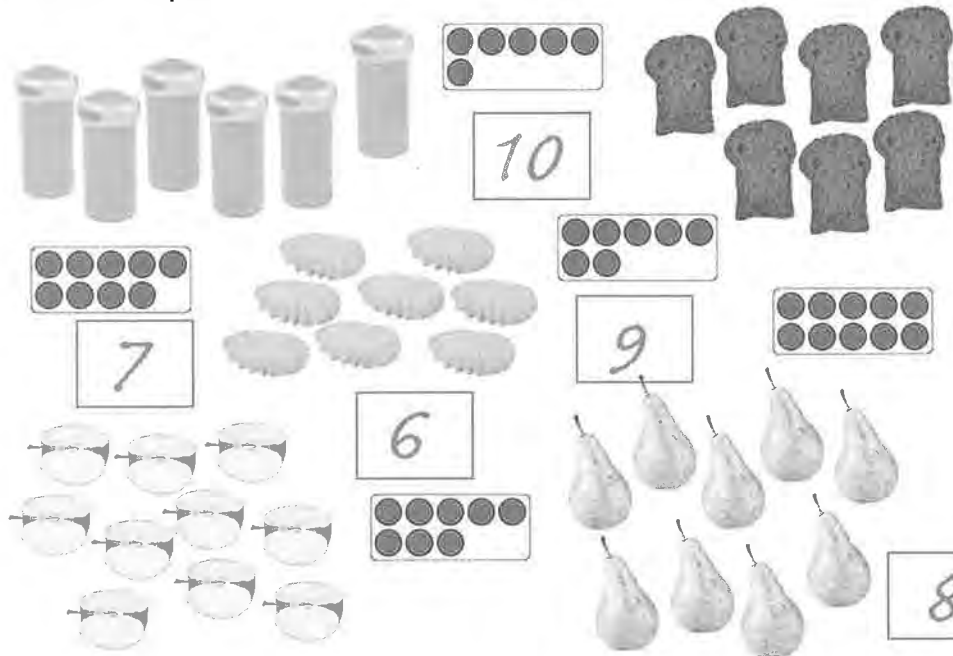

1 conecta cu otro.

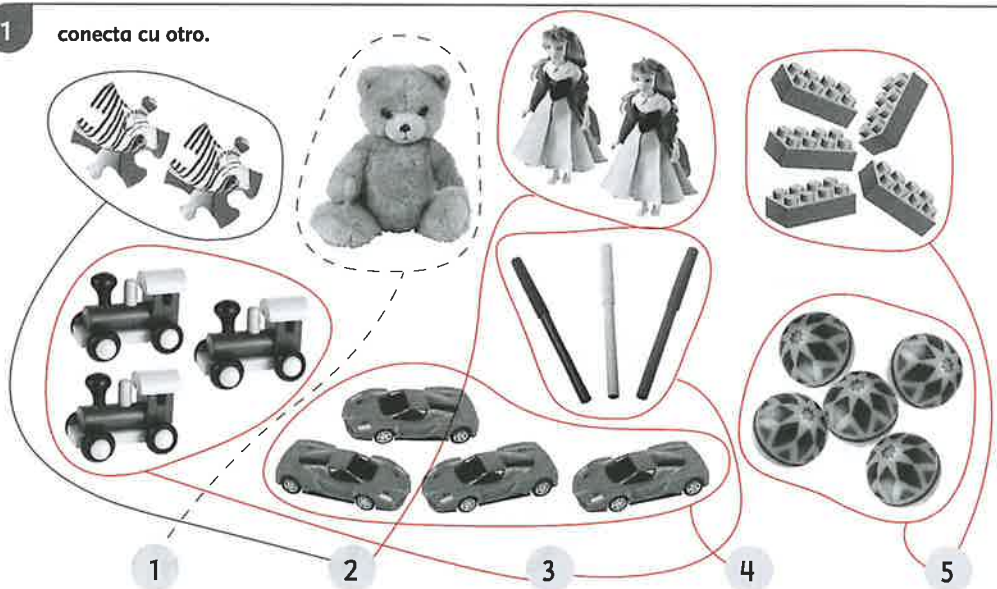

2 cuanto tin?

kleur mes hopi.

		3
		4
		2
		5

3 traha grupo.

a traha grupo di 2.



b traha grupo di 4.



4 pinta mes hopi.

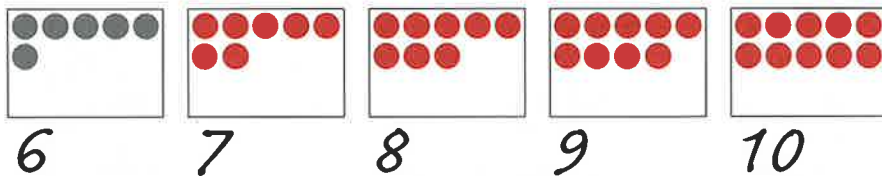

5 conecta cu otro.

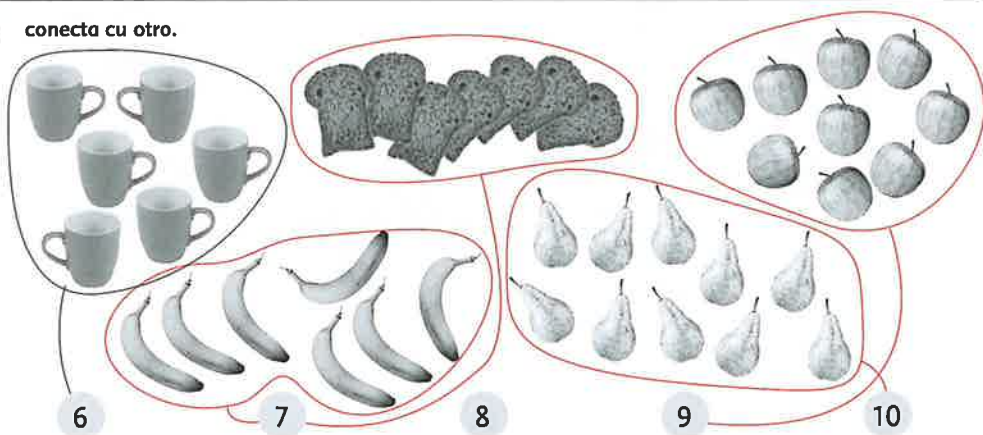

6 cuanto tin?

kleur mes hopi.

		7
		9
		6
		8
		10

1 cuanto mucha tin?



2 tin suficiente, di mas of di menos?



3 juffrouw tambe ta keda come.



4 tin suficiente?











1

cuanto tin?

kleur mes hopi.

skirbi.

		5
		7
		9
		10

2

traha grupo di 7.



3

tin suficiente?

kleur si of no.



si

no

si

no

si

no

si

no



4 conecta cu otro.



6 7 8 9 10

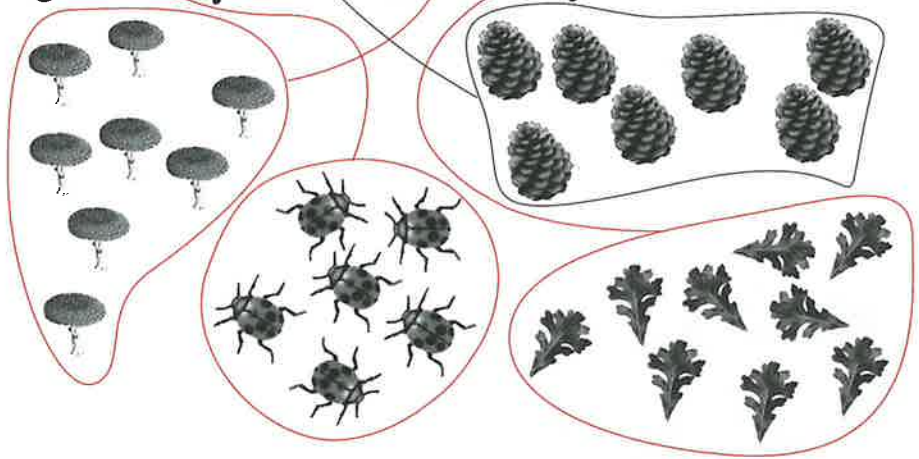

5 traha grupo di 6.

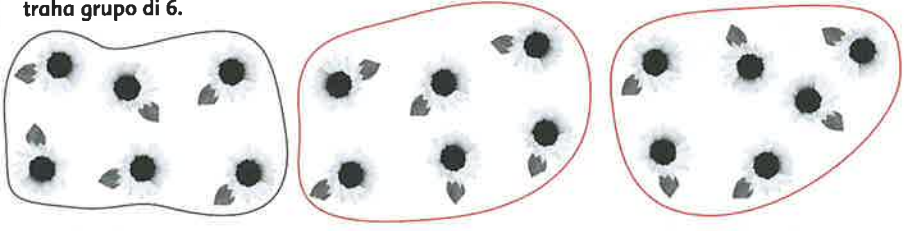

6 pinta 2 mas.

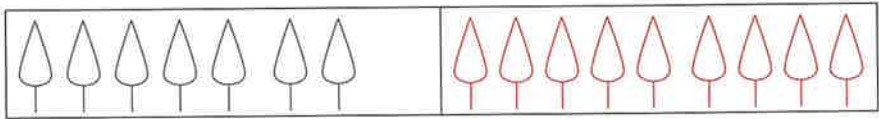

7 pinta 2 menos.

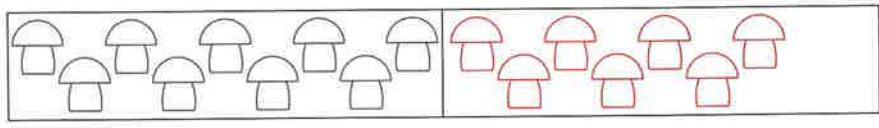

1 conecta cu otro.

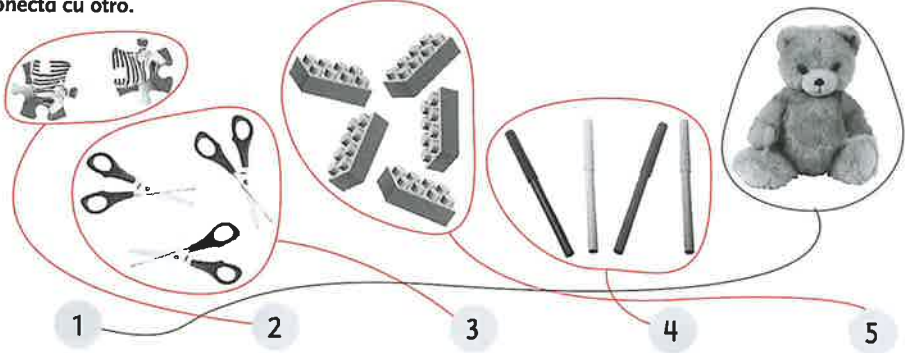

2 cuanto tin? kleur mes hopi.

	●●●○○	3
	●●●●○	4
	●●○○○	2

3 traha grupo.

a traha grupo di 2.

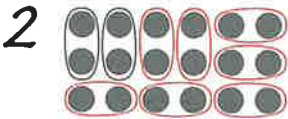

b traha grupo di 4.

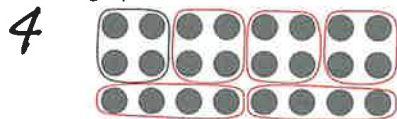

4 traha grupo.

a traha grupo di 5.



b traha grupo di 10.



5 traha grupo di 8.

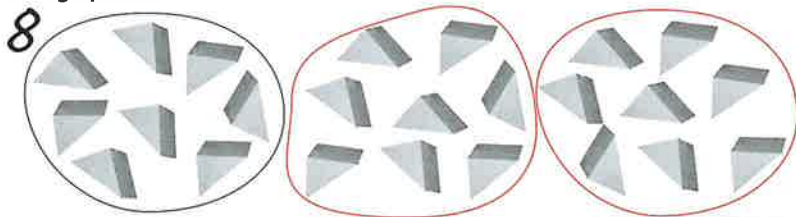

6 traha grupo di 9.

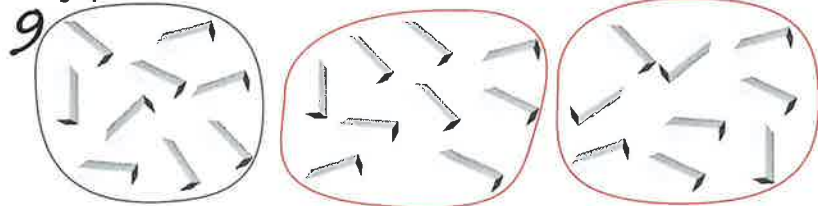

7 cuanto tin?

kleur mes hopi.

skirbi.

		8
		10
		9
		6

8 tin suficiente?

kleur si of no.

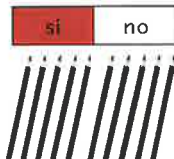

1 dos man pa conta.

tin dos man cu popchi
di hopi colo.
na cada man cinco
ta yama ayo.



conta nan bon
y wak pa bo mes
cu dos biaha cinco
semper ta...

2 kico bo ta ripara?

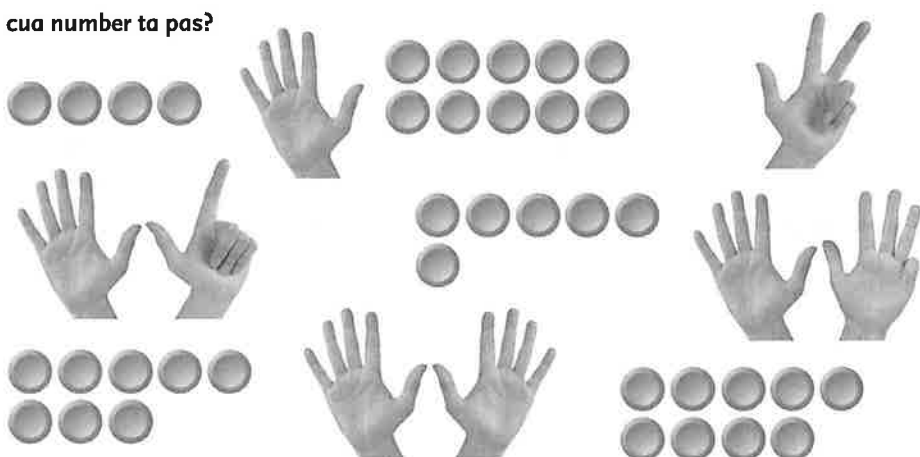
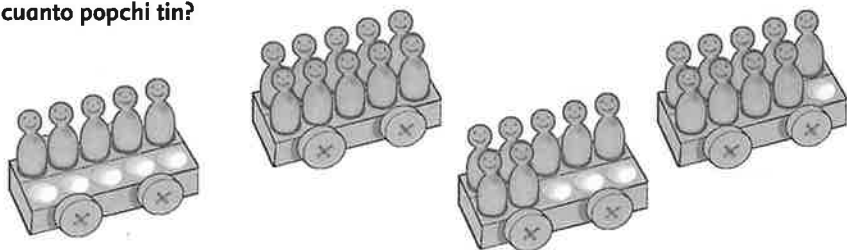
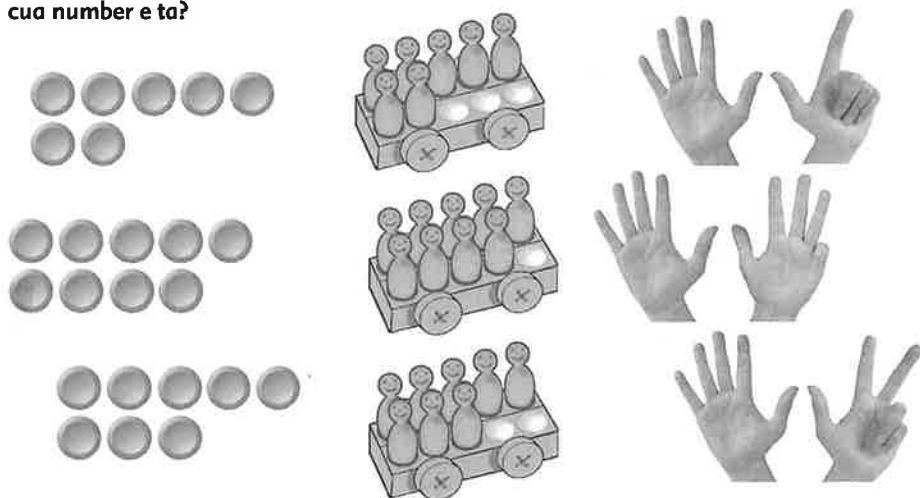

3 **cua number ta pas?**4 **cuanto popchi tin?**5 **cua number e ta?**

1 conecta cu otro.

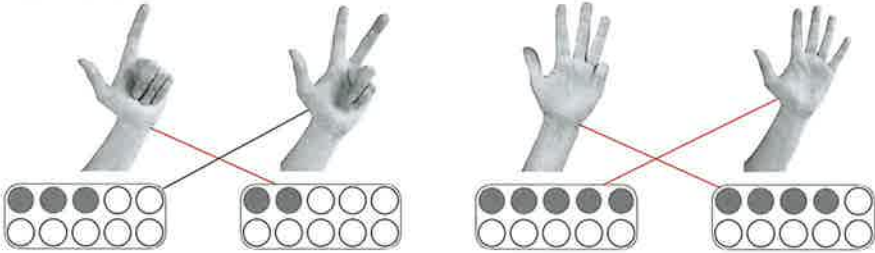

2 conecta cu otro.

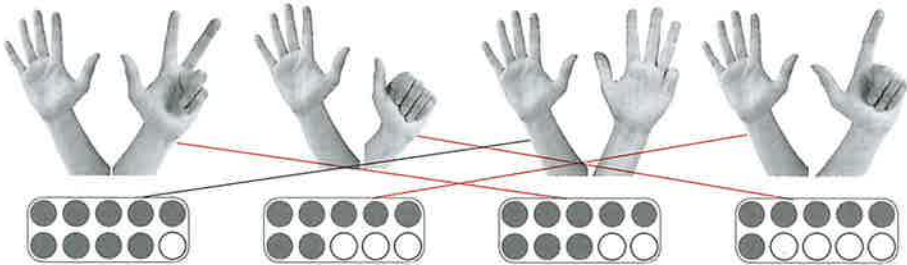

3 kleur e cantidad.

kleur 4 ●●●● ○○○○



kleur 6 ●●●●●● ○○○○

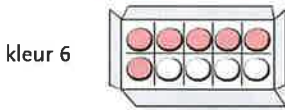

kleur 8 ●●●●●●●● ○○

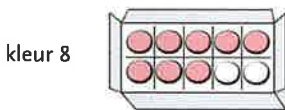

- 4 kleur cada biah 5 bala.
despues traha grupo di 10.

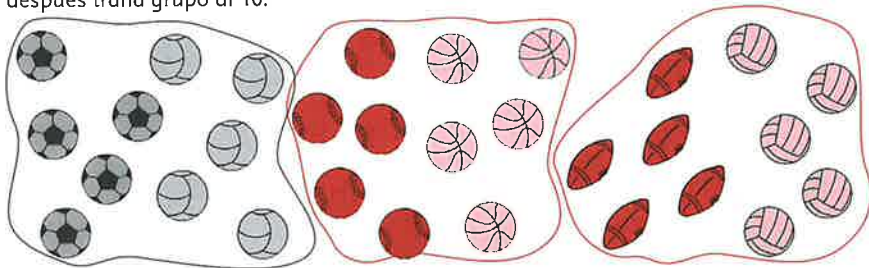

- 5 kleur cada biah 5 blaas.
despues traha grupo di 10.

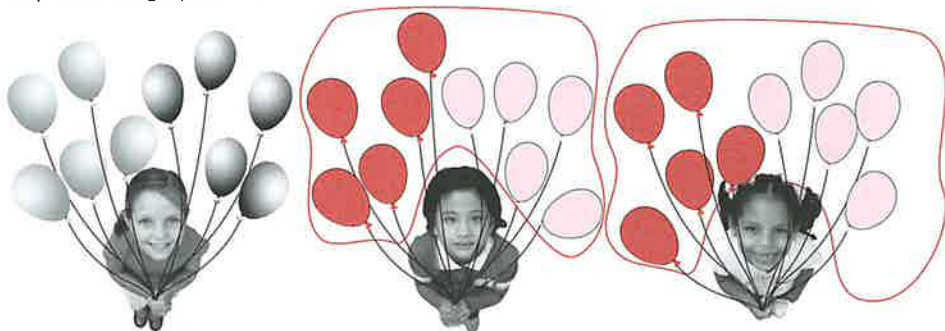

- 6 kleur cada biah 5 hemchi.
despues traha grupo di 10.



- 7 cua di nan ta 10?
conecta nan cu number 10.

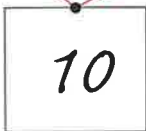

1 cuanto wowo bo ta tira?



2 ken ta gana?



3 gibi y wina ta tira dou dos biaha.
ken ta gana?



gibi ta tira:

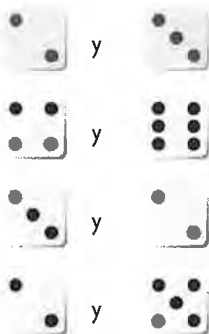

wina ta tira:

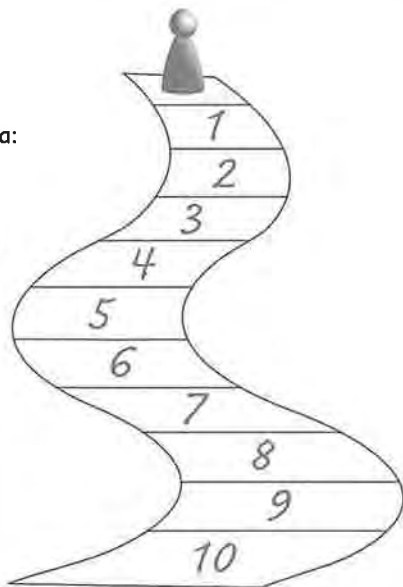
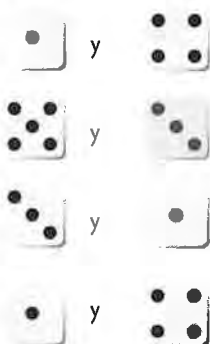

4 cuanto popchi tin?

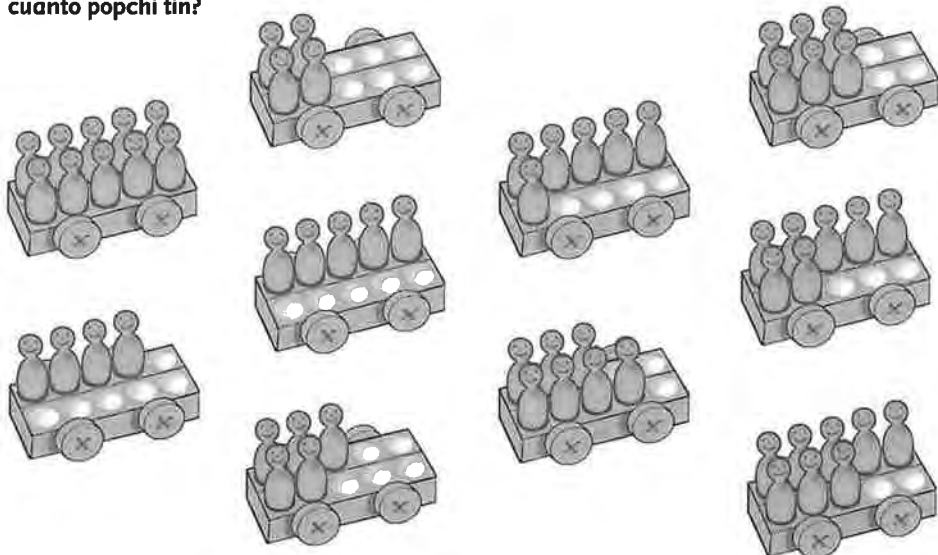

1 conecta cu otro.

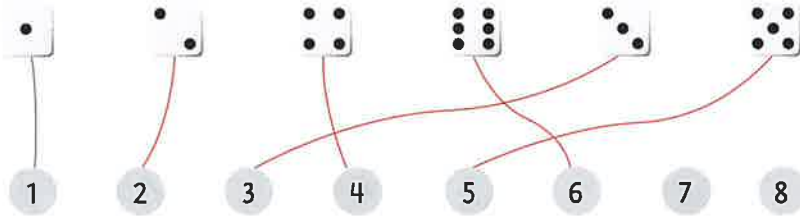

2 pinta e wowonan.

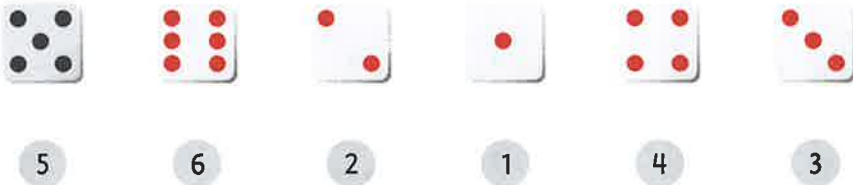

3 cuanto tin?

kleur mes hopi.

skirbi.

		6
		8
		9
		10

4 yena e numbernan.











5

quanto tin?

kleur mes hopi.

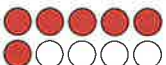
skirbi.

		9
		7
		10
		6
		8





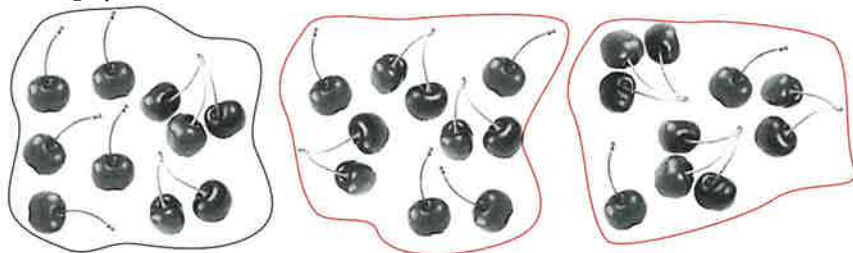



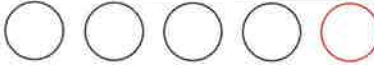

6

traha grupo di 10.

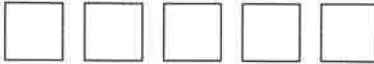

7

completa rij di 10.

18

blok 1

les 15 ripiti

1

conecta cu otro.



2

kleur e cantidad.



3

yena e numbengan.



4

yena e numbengan.



5

kleur cada biaha 5 shobel.
despues traha grupo di 10.

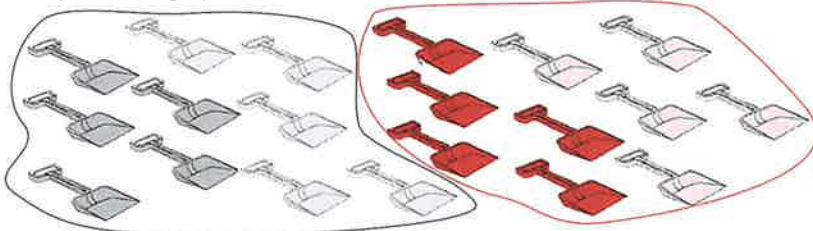

6 traha grupo di 2.

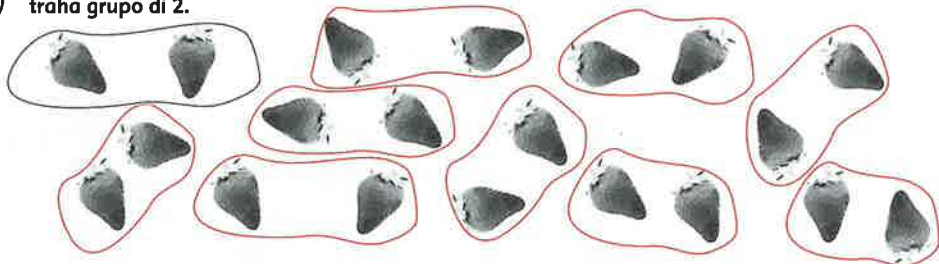

7 traha grupo di 5.



8 pinta 3 menos.

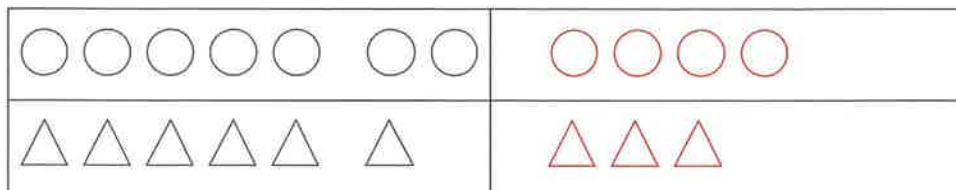

9 pinta 3 mas.

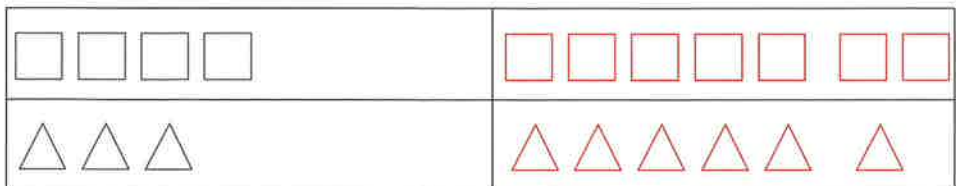

1 cuanto e mester paga?



2 cuanto nan ta hunto?



3 cuanto regalo bo por compra?



4 kico bo por compra?



5 con bo ta paga?



1 conecta cu otro.

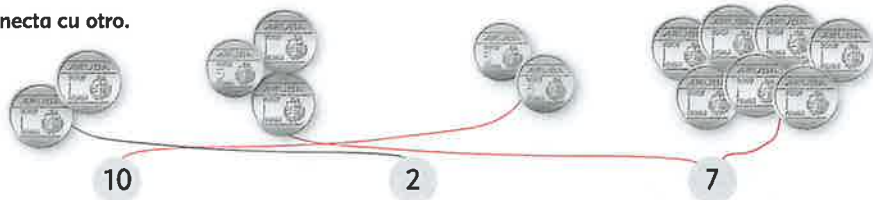

2 cuanto florin tin?



3 cuanto florin tin?

kleur mes hopi.

skirbi.

		3
		5
		5
		7
		10
		7
		8

- 4 **kleur cada biaha 5 copi.**
despues traha grupo di 10.

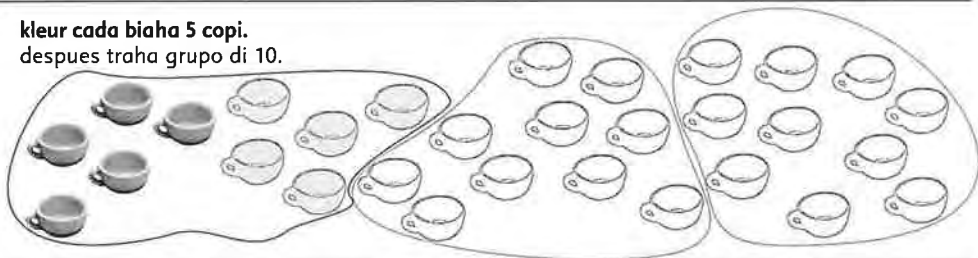

- 5 **pinta.**
a pinta 2 menos.



- b pinta 2 mas.

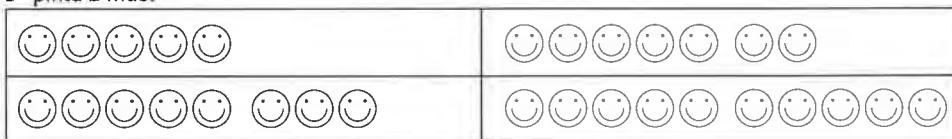

- 6 **yena e numbernan.**



- 7 **mes hopi dede.**
conecta cu otro.

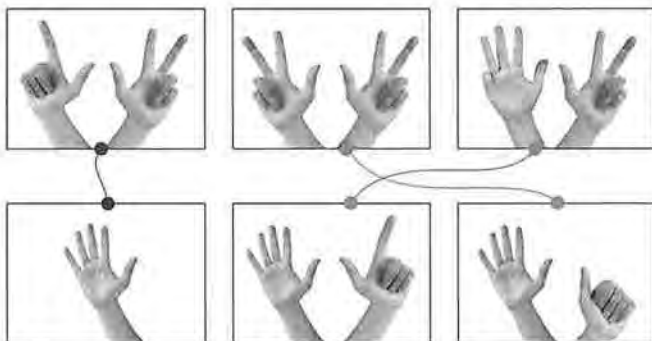

1 ban hunga kiniki.



2 split.



3 quanto wortel e coneu ta come?

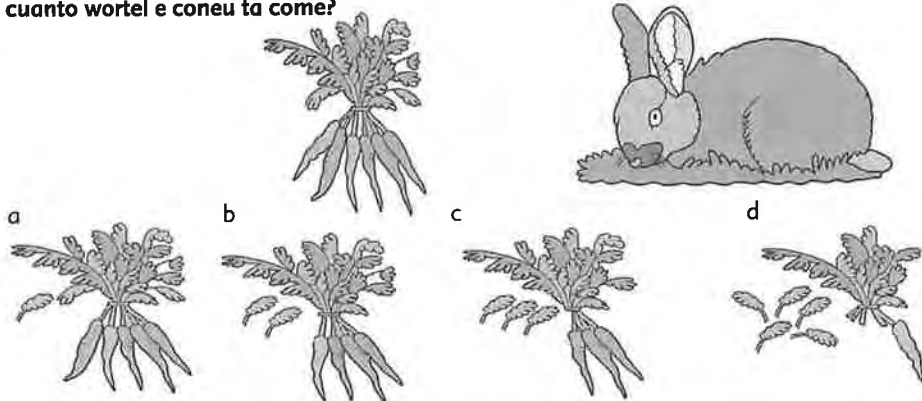

4 split.

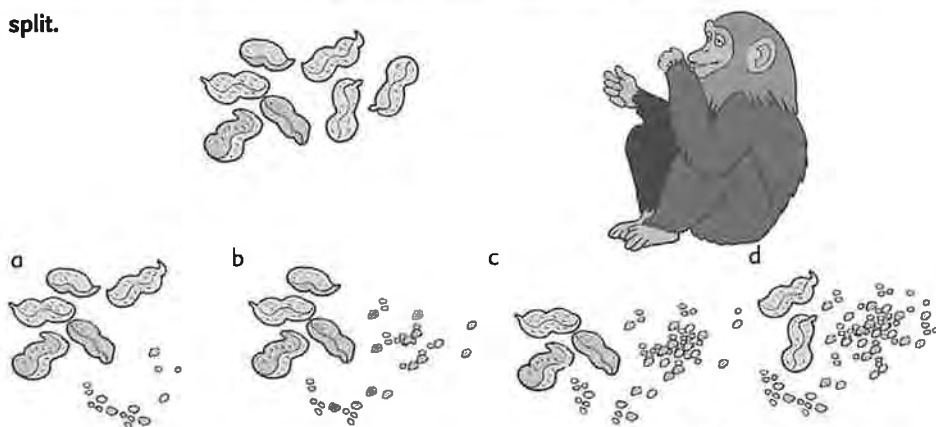

5 split.
tira 8.

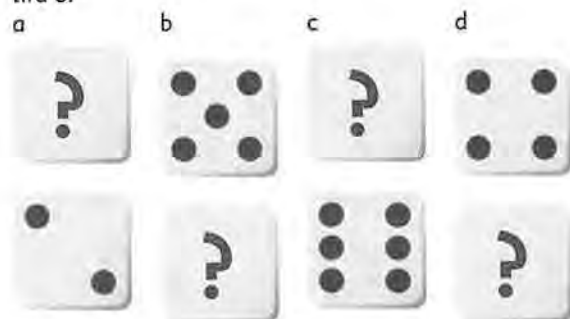

1 quanto tin di cada colo?

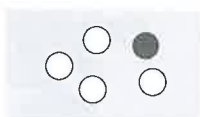
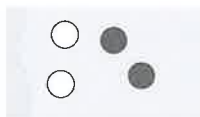
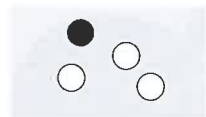

2 con ta split?

○ ○ ○ ●	3	1
○ ○ ● ●	2	2
○ ● ● ●	1	3

○ ○ ○ ○ ●	4	1
○ ○ ○ ● ●	3	2
○ ○ ● ● ●	2	3
○ ● ● ● ●	1	4

3 quanto tin?



7



7



6



8



8



9

4 pinta ronchi.

a 6 ronchi



b 4 ronchi



c 8 ronchi



d 10 ronchi



5 cuanto tin di cada colo?

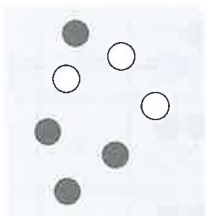

○ 3 ● 4

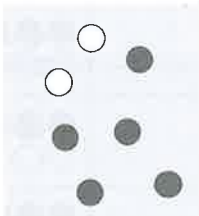

○ 2 ● 5

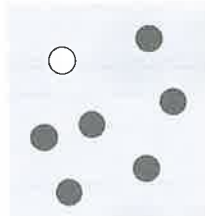

○ 1 ● 6

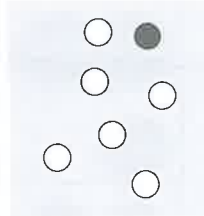

○ 6 ● 1

6 split.

a yena con ta split.

○ ○ ○ ○ ○ ●	6	1
○ ○ ○ ○ ○ ● ●	5	2
○ ○ ○ ○ ● ● ●	4	3
○ ○ ○ ● ● ● ●	3	4
○ ○ ● ● ● ● ●	2	5
○ ● ● ● ● ● ●	1	6

b kleur con ta split.

○ ○ ○ ● ● ●	3	3
○ ○ ○ ○ ● ●	4	2
○ ● ● ● ● ●	1	5
○ ○ ● ● ● ●	2	4
○ ○ ○ ○ ○ ●	5	1
○ ○ ○ ● ● ●	3	3

7 traha grupo di 9.











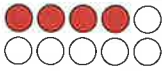

1

cuanto florin tin?

kleur mes hopi.





skirbi.

		4
		5
		8
		9
		9
		10





2

split.

a yena con ta split.

	5	1
	4	2
	3	3
	2	4
	1	5

b kleur con ta split.

	2	3
	4	1
	3	2
	1	4

3

cuanto ta keda den e cahá?



6



5



3



1

4 cuanto tin?

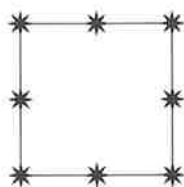

8

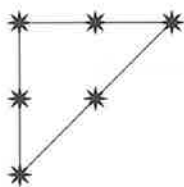

6

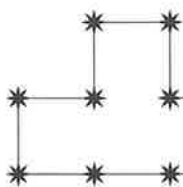

10

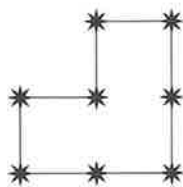

8

5 traha grupo di 8.

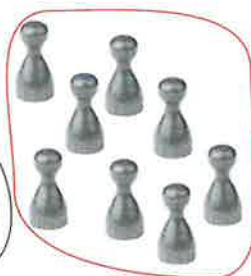

6 pinta 2 mas.

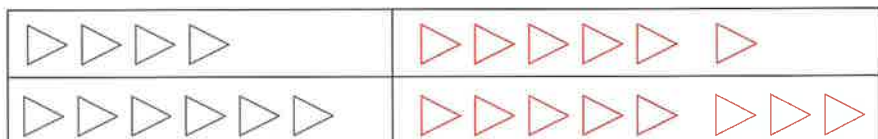

7 pinta 3 menos.



8 yena e numbernan.



1 kico e numbernan aki ta bisa bo?

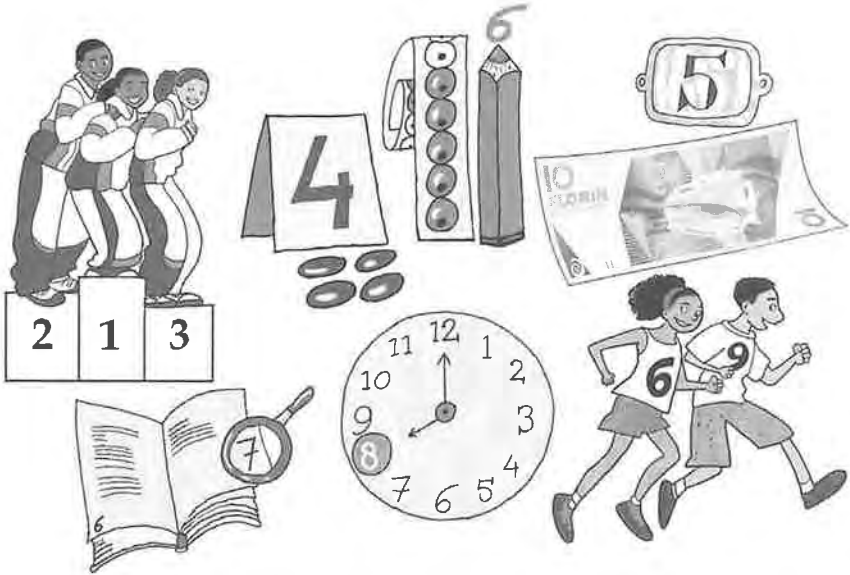

2 con largo nan ta?

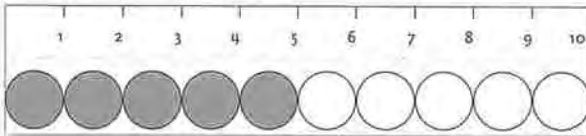

3 con grandi nan ta?

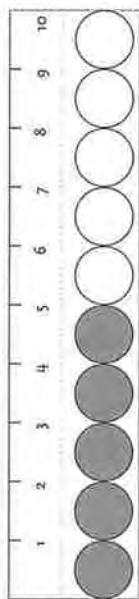

4 con bo por midi?



5 yena e glas te 3,
te 5, 7, 6, 10, 4, 8.



1 con largo?



6

9

5

10

2 con halto?



3

7

5

8

2

9

4

3 con largo cada pida ta?

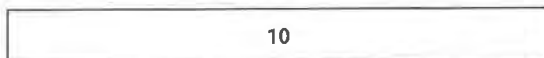
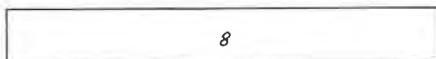

4 e puzel tin 9 pida.
cuanto pida ta keda den e caja?



9



7



4



8



2



6

1 kico rita y nico ta haci?

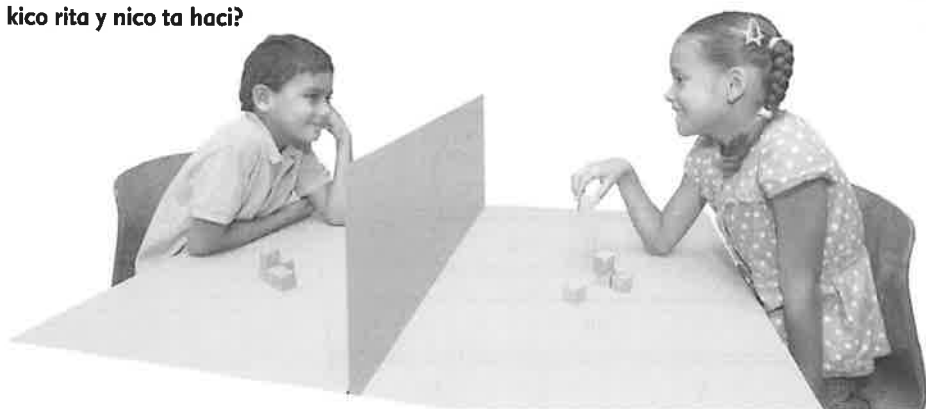

haci mescos cu rita y nico.

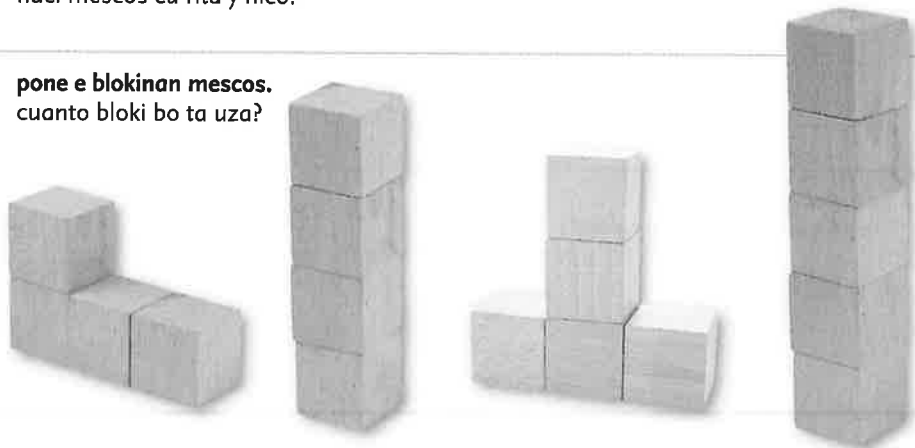
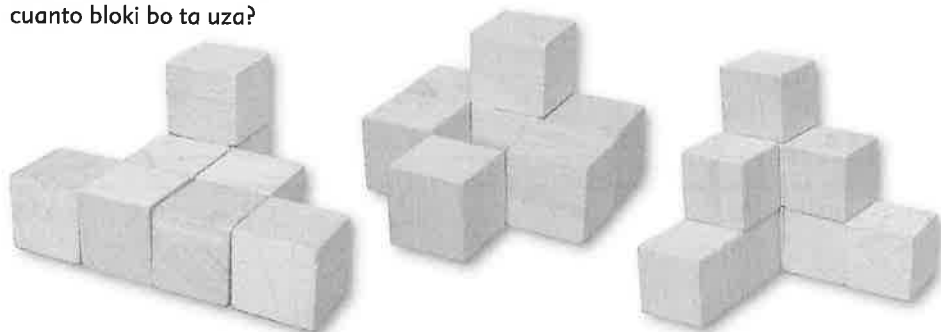
2 pone e blokinan mescos.
cuanto bloki bo ta uza?3 pone e blokinan mescos.
cuanto bloki bo ta uza?

4 **cua di nan ta mescos?**

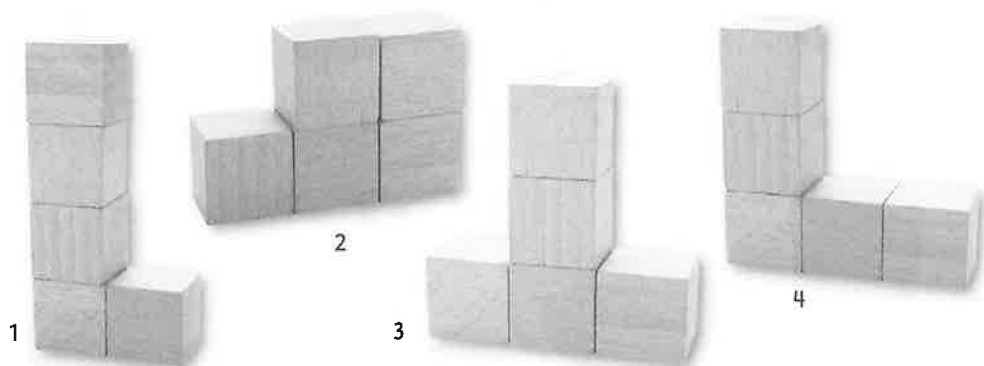
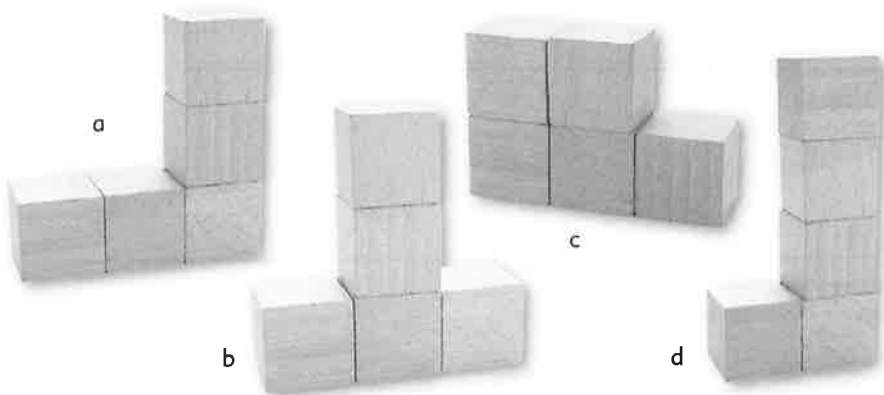

5 **traha cu 5 bloki.**
cada biah diferente.

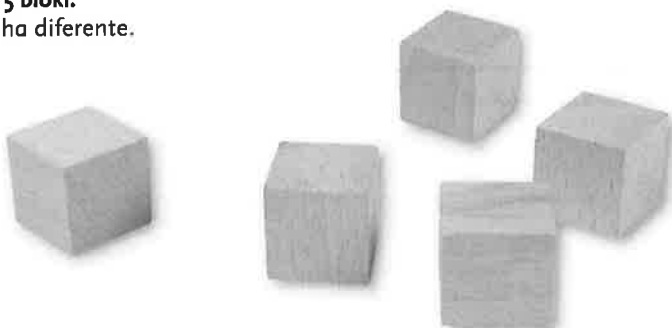

1

pone e blokinan mescos.



2

cuanto bloki tin?

pone e blokinan mescos.



4



4



10



6



6



7



9



6

3

cuanto bloki ta keda den e cahá?



8



7



4



5

4

cua di nan ta mescos?
duna nan e mesun colo.

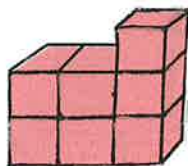
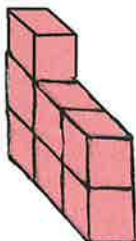
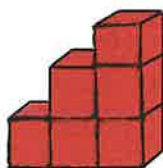
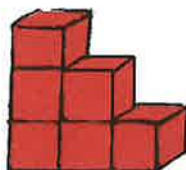
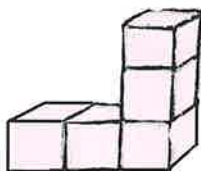
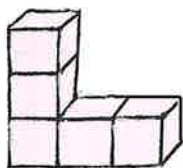

5

cuanto bloki ta keda den e caha?



9



3



5



7

6

conta bay bek.



30

blok 1

les 25 ripiti

1

con halto?

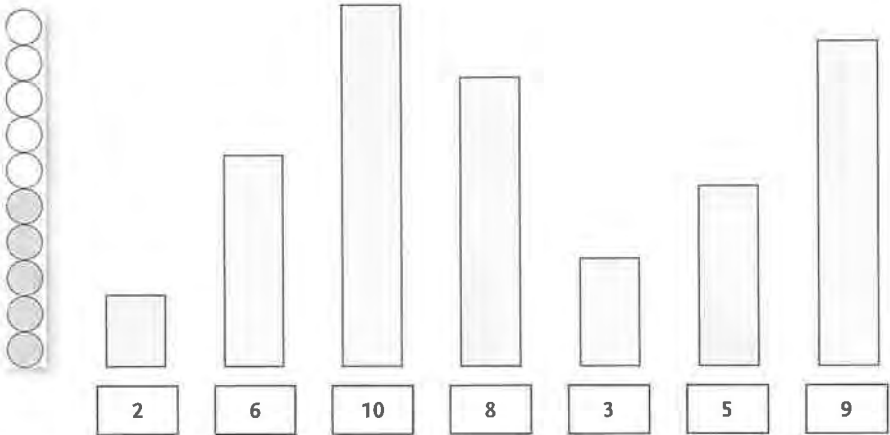

2

con largo cada pida ta?

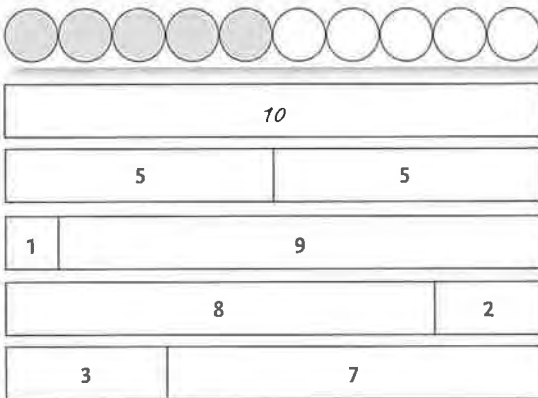

3 cuanto tin di cada colo?

○ <input type="text" value="4"/> ● <input type="text" value="2"/>	○ <input type="text" value="1"/> ● <input type="text" value="5"/>	○ <input type="text" value="3"/> ● <input type="text" value="3"/>	○ <input type="text" value="2"/> ● <input type="text" value="4"/>

4 kleur con ta split.

○○○○○○●	6	1
○○○○○○●●	5	2
○○○○●●●	4	3
○○○○●●●●	3	4
○○●●●●●	2	5
○●●●●●●	1	6

○○○●●●	3	3
○○○○●●	4	2
○●●●●●	1	5
○○●●●●●	2	4
○○○○○●	5	1







5 cuanto bloki ta keda den e caha?

<input type="text" value="9"/>	<input type="text" value="4"/>	<input type="text" value="6"/>	<input type="text" value="8"/>

6 yena e numbernan.

1 <input type="text" value="2"/> 3 <input type="text" value="4"/> 5	3 <input type="text" value="4"/> 5 <input type="text" value="6"/> <input type="text" value="7"/>
2 <input type="text" value="3"/> 4 <input type="text" value="5"/> 6	6 <input type="text" value="7"/> 8 <input type="text" value="9"/> <input type="text" value="10"/>
6 <input type="text" value="7"/> 8 9 <input type="text" value="10"/>	4 <input type="text" value="5"/> <input type="text" value="6"/> <input type="text" value="7"/> 8

1 cuanto tin? kleur mes hopi.

		4
		2
		5

2 traha grupo di 5.

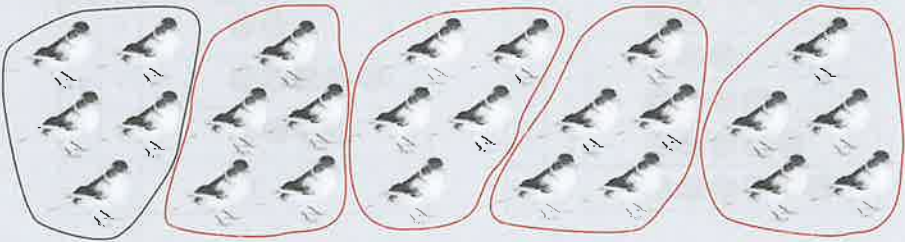

3 conecta cu otro.

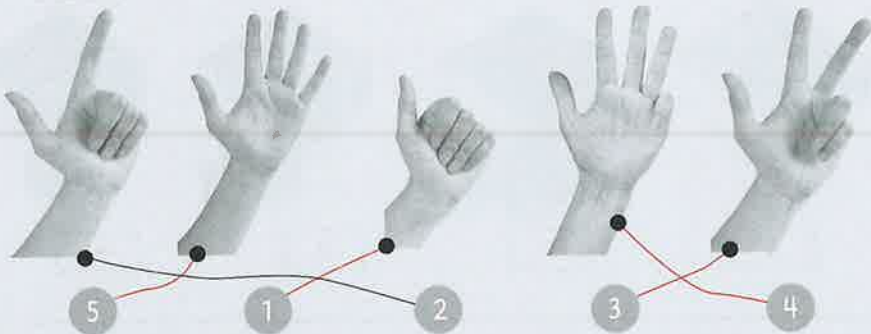



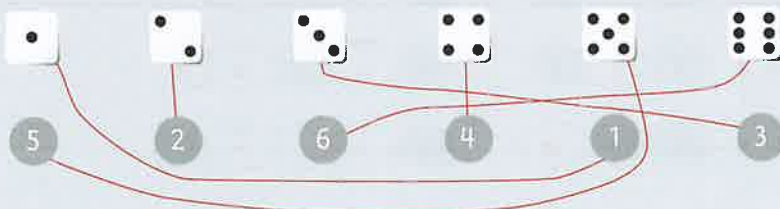





4 conecta cu otro.

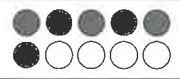

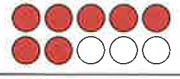
5

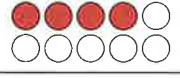
cuanto tin?

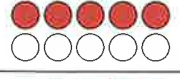
kleur mes hopi.

		6
		7
		4
		5
		8

6

conecta cu otro.

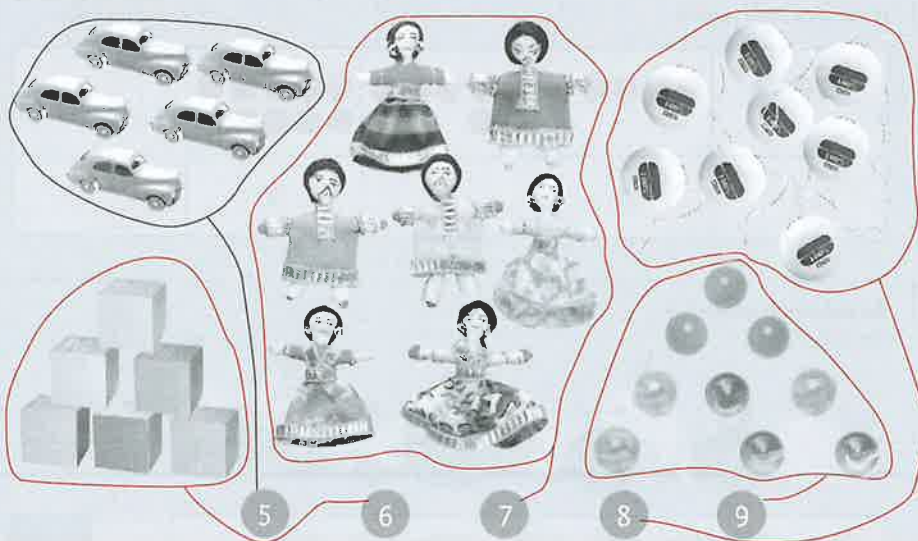

7

conecta cu otro.



1 traha grupo di 3.



2 traha grupo di 6.



3 pinta mes hopi ronchi.

abo mes awor.

3	5	7	9	

4 tin suficiente cuminda?
kleur si of no.

	si	no
	si	no
	si	no

5 pinta 3 mas.

○ ○ ○ ○ ○	○ ○ ○ ○ ○ ○ ○ ○ ○
○ ○ ○ ○ ○ ○ ○	○ ○ ○ ○ ○ ○ ○ ○ ○

6 pinta 2 menos.

△ △ △ △ △	△ △ △
△ △ △ △ △ △	△ △ △ △

7 traha grupo di 8.

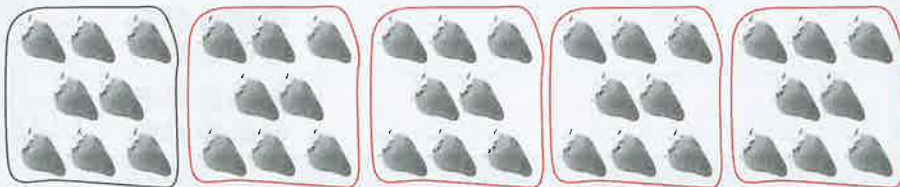

8 yena e numbernan.

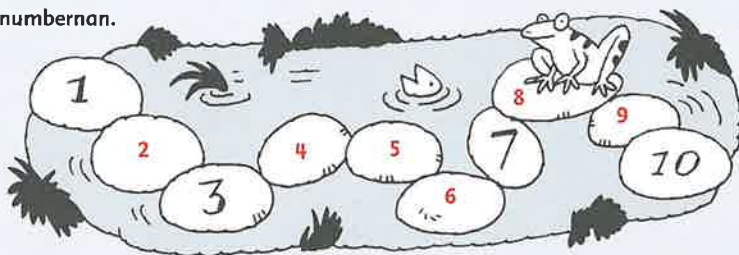

9 cuanto tin di cada colo?

○ 3 ● 2 ● 1	○ 4 ● 4	○ 5 ● 4	○ 5 ● 1

1 conecta e numbernan cu otro.

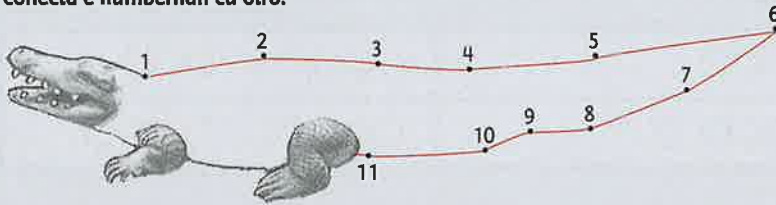
2 cuanto tin?
pinta e figuranan..

kleur mes hopi.

		6
		8
		9
		10

3 conecta cu otro.

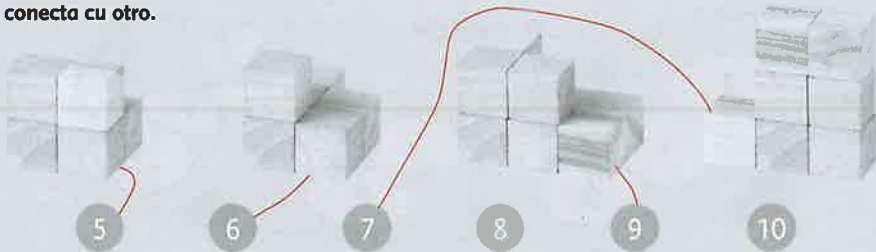
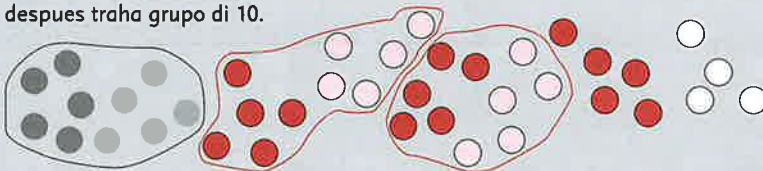
4 kleur cada biaha 5 ronchi.
despues traha grupo di 10.kico bo ta ripara? **falta 1 ronchi.**

5 pinta e wowonan na diferente manera.



6 cuanto tin hunto?

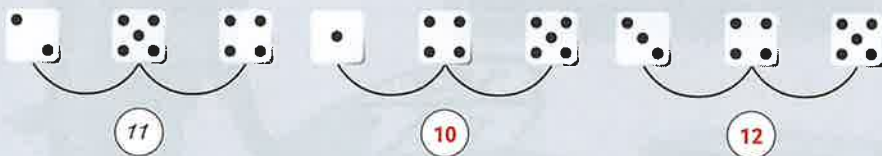

7 pinta e wowonan.



8 conecta e numbertan.
salta 1 number cada biaha.

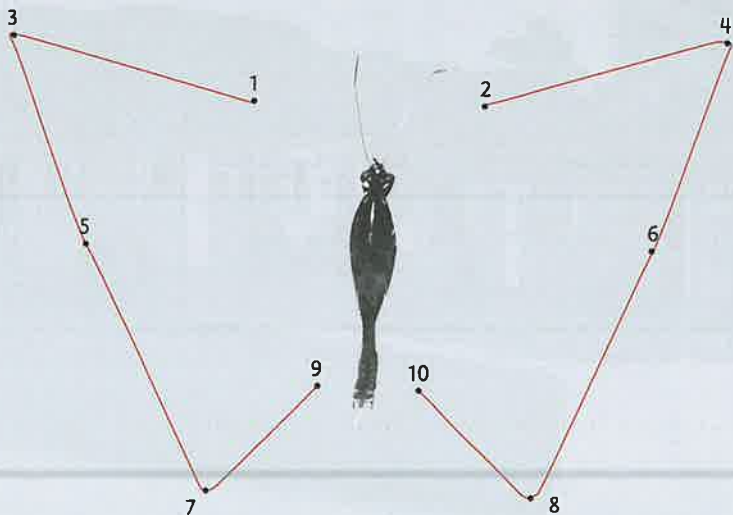

1 kico e numbranan aki ta bisa bo?

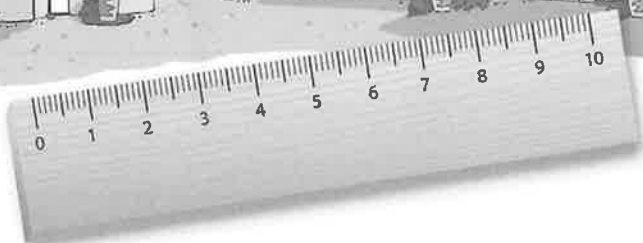
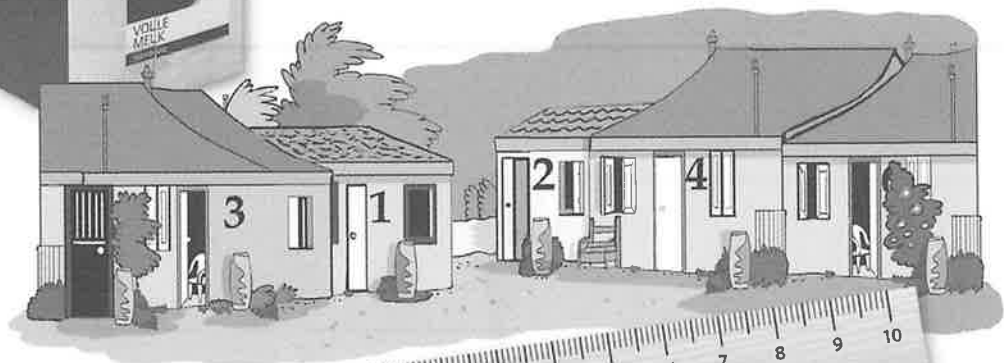

2 **cua number ta pas?**

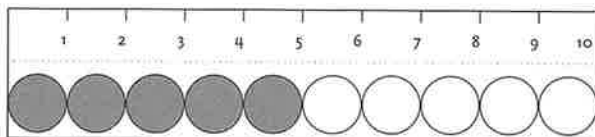

3 **unda cu bo bira ta number bo ta mira.**

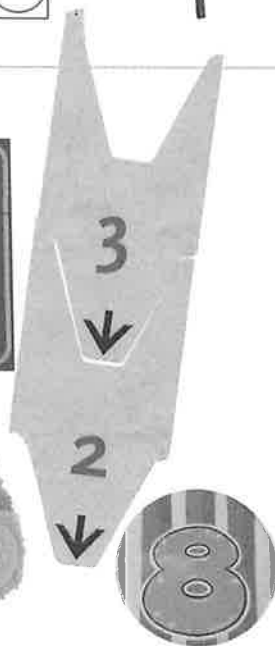
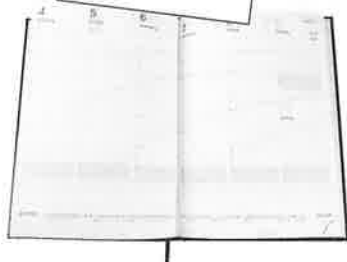

4 **cuminsa traha den bo buki di conta.**

38

blok 2

les 2

1

kleur.

kleur e plachinan cu 5 geel.

kleur e plachinan cu 8 cora.

kleur e plachinan cu 9 blauw.

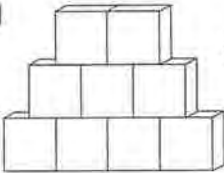
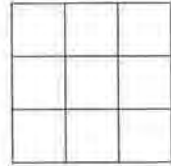
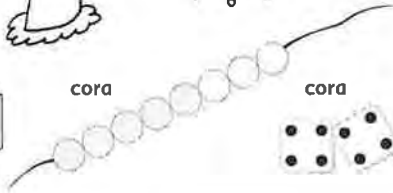
blauw**blauw****geel****geel****geel****geel****blauw****cora****dialuna****juli****cora****cora**

2

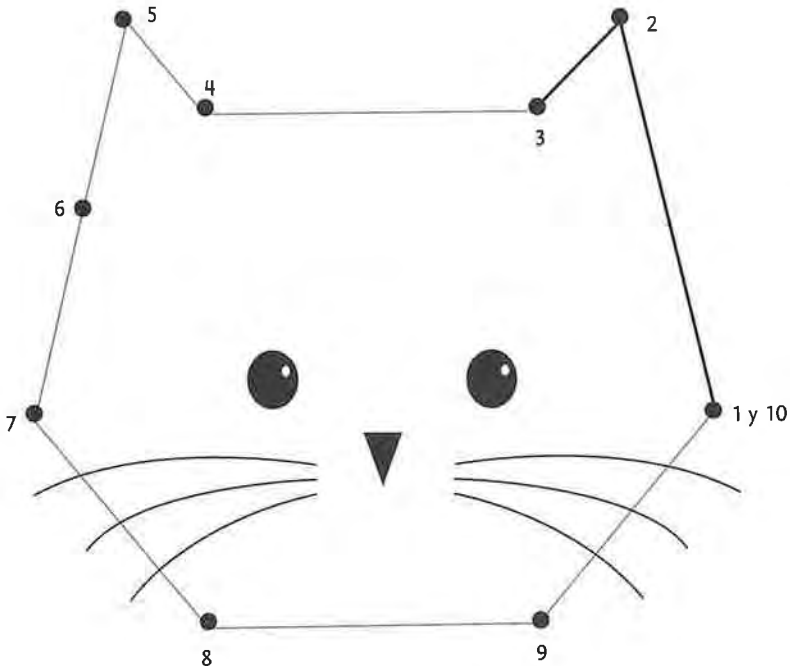
conecta e numbranan cu otro.

3 conecta cu otro.

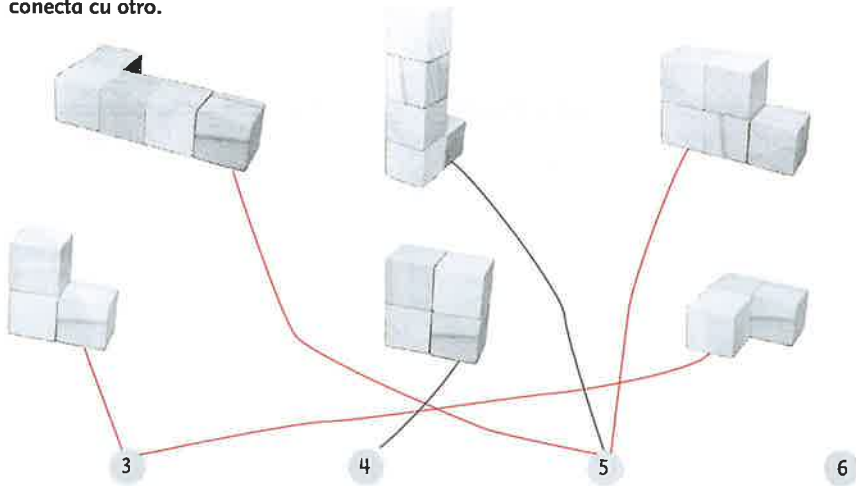

4 conecta cu otro.

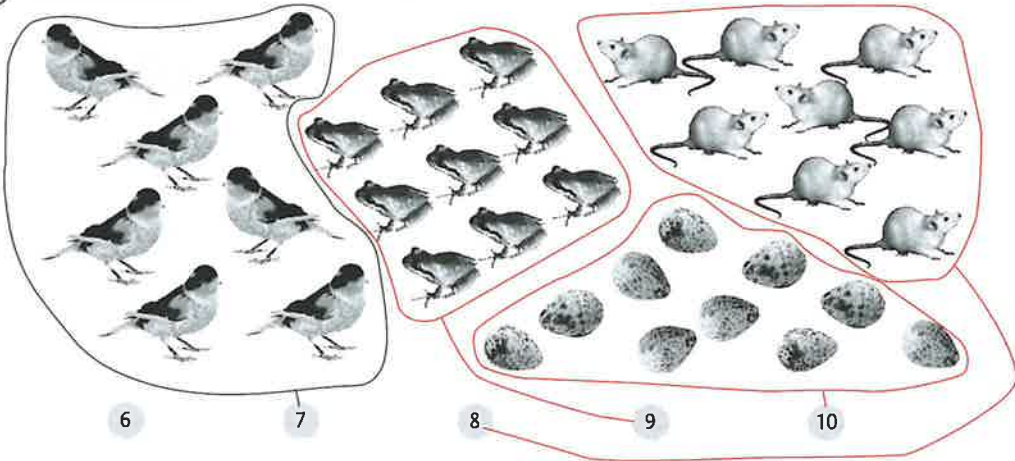

5 traha grupo di 8.



1 den cua cartera tin 10 florin?

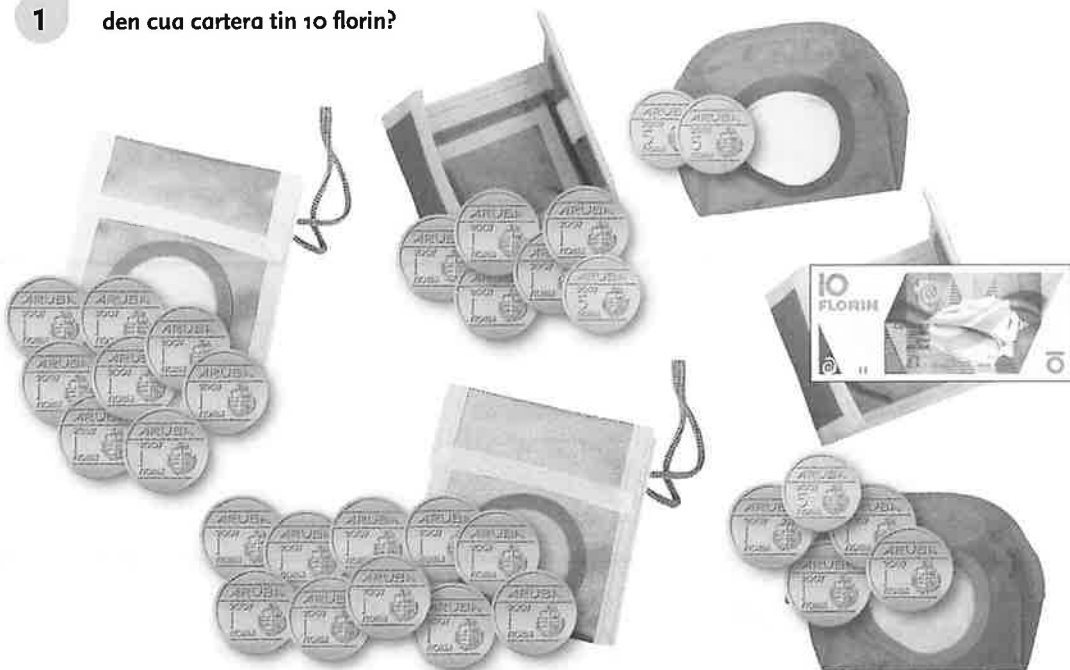

2 cuanto bo mester paga?

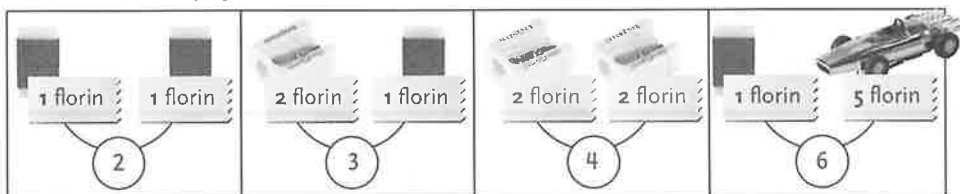

3 cuanto bo mester paga?

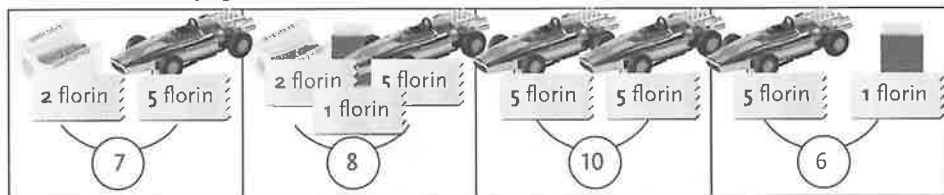

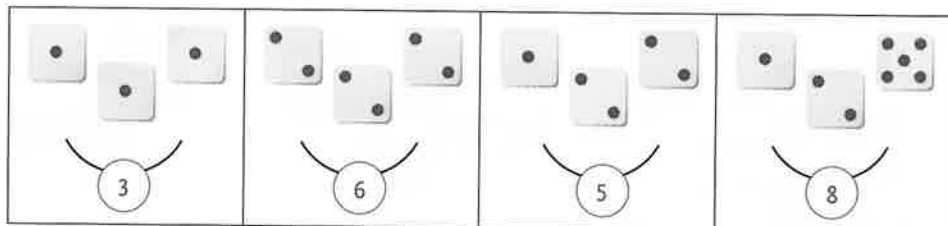
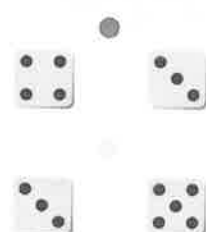
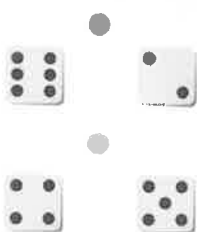
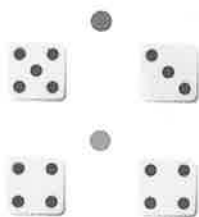
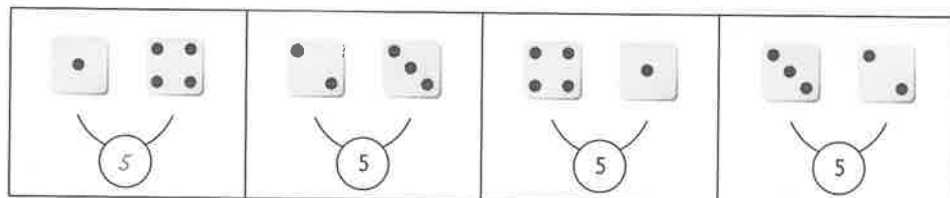
4 **cuanto tin hunto?**5 **cua di nan hunto ta 8?**6 **cuanto tin hunto?**7 **sigui traha den bo buki di conta.**

- 1 **bo ta paga f 5.**
kico bo por cumpra?
kleur nan.



mas cu 1 contesta.



- 2 **hunto tin 10 florin.**
cuanto florin tin den e cartera?



- 3 **kleur e cartera cu tin 1 florin menos.**

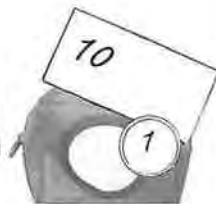

4 cuanto tin hunto?

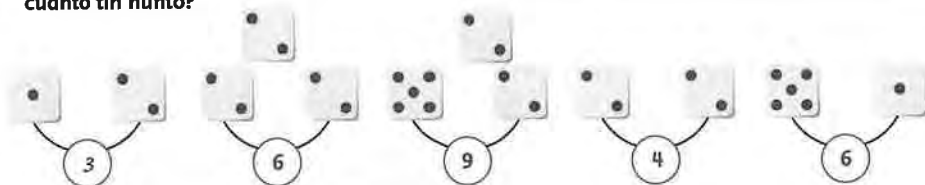

5 cuanto tin hunto?

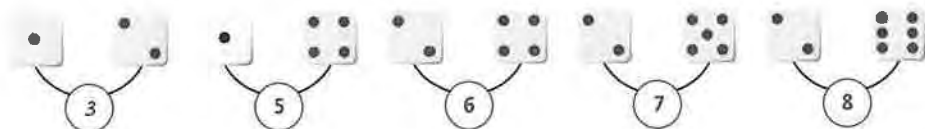

6 cuanto tin hunto?

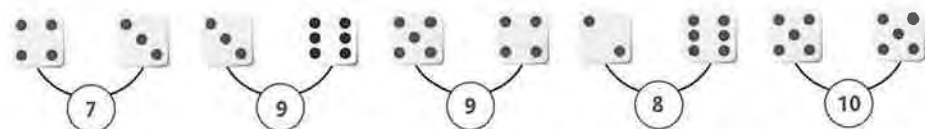

7 yena number y pinta ronchi.

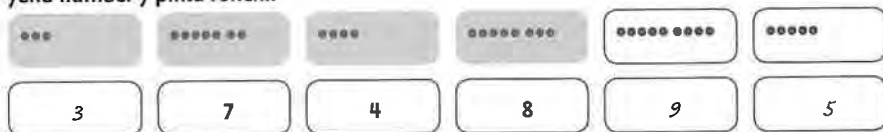

8 conecta cu otro.

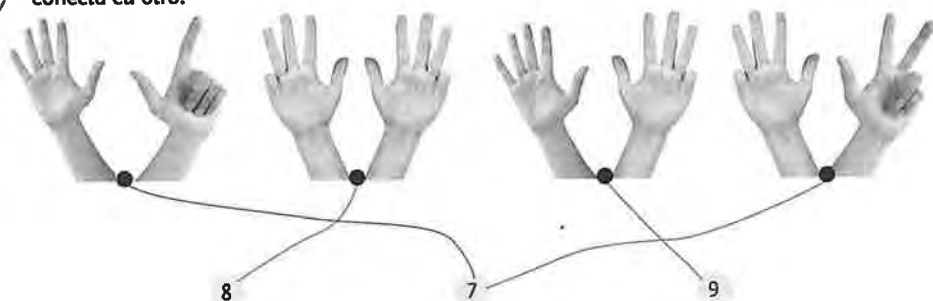

- 1 cada mucha ta haya 10 blaas.
pinta e cintanan.

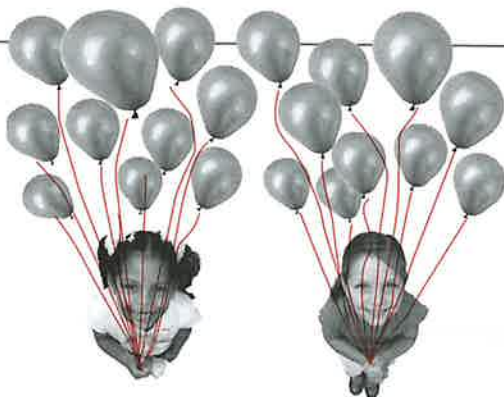

- 2 traha grupo di 7.

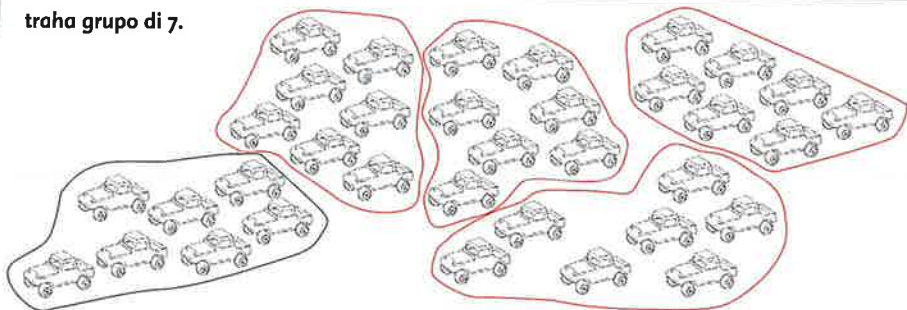

- 3 cuanto tin hunto?



6 wowo



8 wowo



10 wowo



9 wowo

- 4 pinta 6 florin na diferente manera.

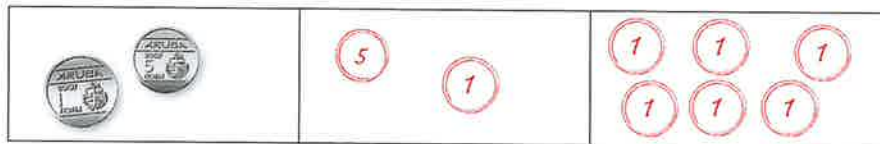

5 yena e numbernan.



6 con abo ta sigui kleur?

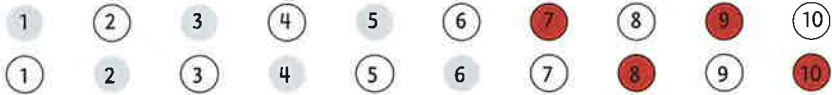

7 conecta cu otro.

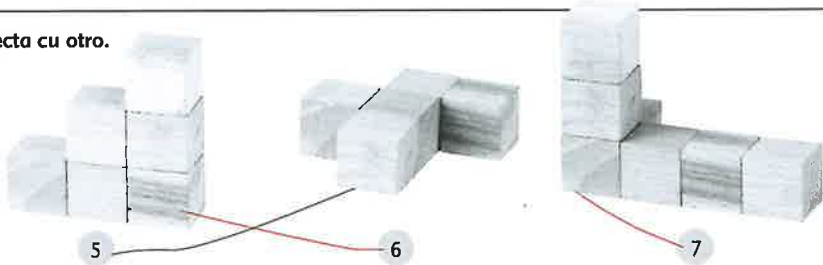

8 traha grupo.
a di 9.

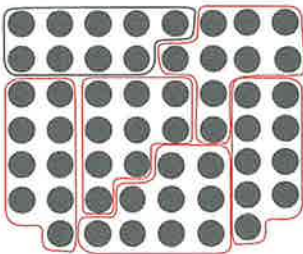

b di 10.

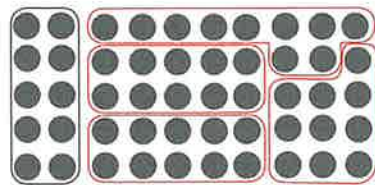

9 conecta cu otro.



5

6

7

8

9

10

1 split 6.



2 split.

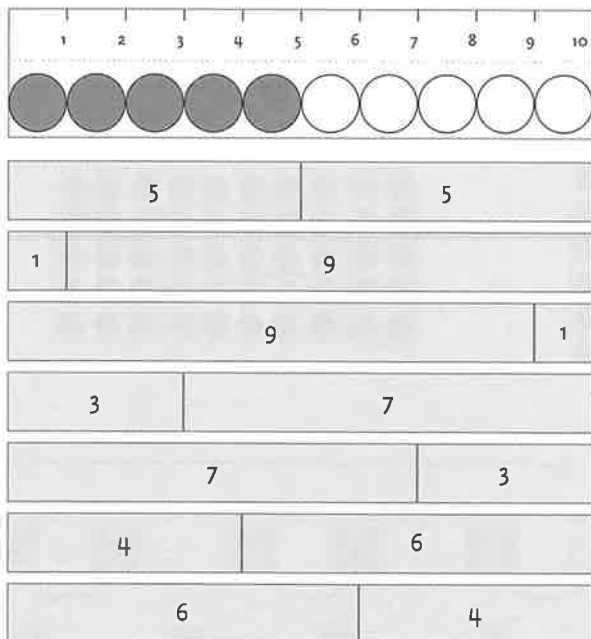

3 quanto bo mester pone acerca?

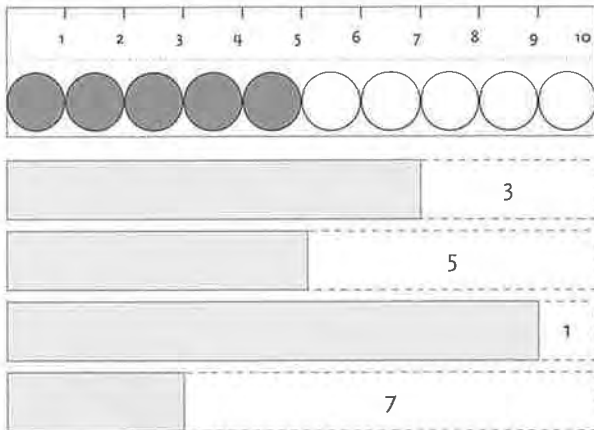

4 split.

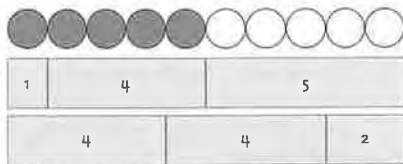
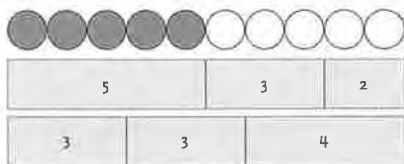

5 cuanto tin hunto? mas cu 1 contesta. split na un otro manera.

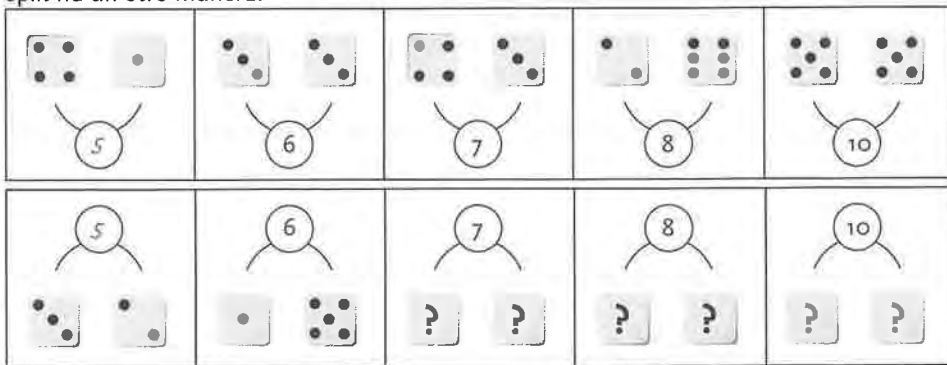

6 sigui traha den bo buki di conta.

1 split.

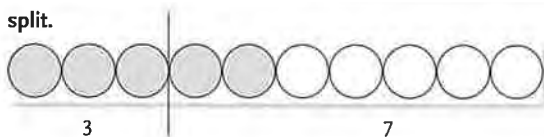

3

7

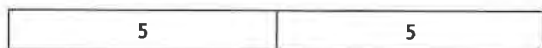

2 cuanto tin hunto?

split na un otro manera. mas cu 1 contesta.

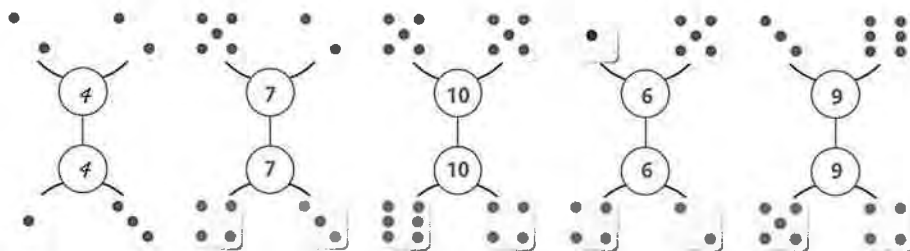

3 split.

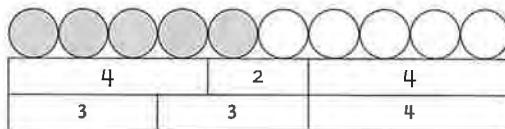
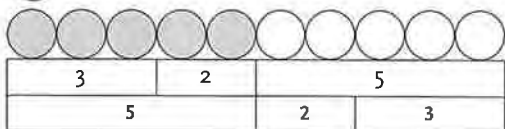

4

cuanto tin hunto?

split na un otro manera. mas cu 1 contesta.

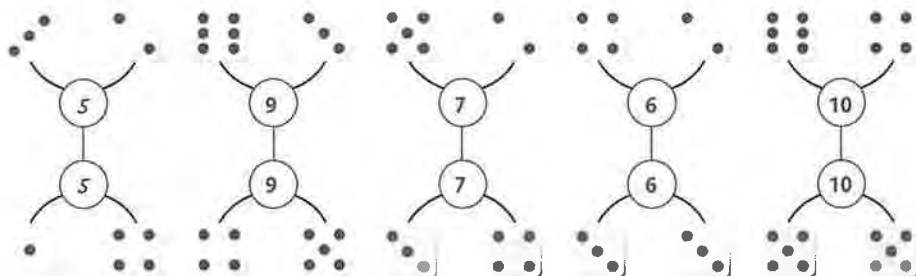

5

cuanto tin hunto?



6

kleur e monedanan.

a



b



c



1 tica tin 5 ficha.



2 split 7.
cuanto tin bou di e beker?



$$7 \begin{cases} 3 \\ 4 \end{cases}$$



$$7 \begin{cases} 5 \\ 2 \end{cases}$$



$$7 \begin{cases} 4 \\ 3 \end{cases}$$

3 split 8.
cuanto tin bou di e beker?



$$8 \begin{cases} 2 \\ 6 \end{cases}$$



$$8 \begin{cases} 4 \\ 4 \end{cases}$$

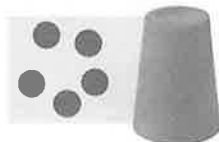

$$8 \begin{cases} 5 \\ 3 \end{cases}$$

4 **split 5.**
cuanto tin bou di e beker?

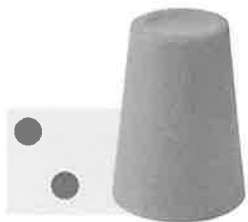

3

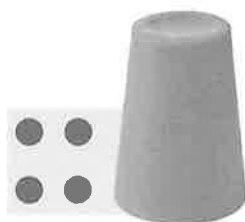

1

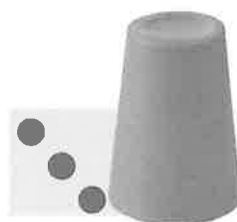

2

5 **split 6.**
cuanto tin bou di e beker?

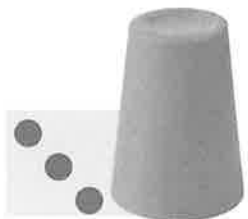

3

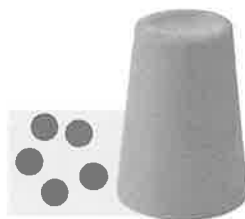

1

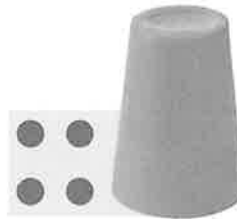

2

6 **split.**
cuanto tin bou di e beker?

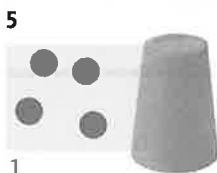

1

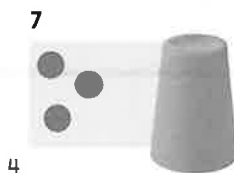

4



7



1



3

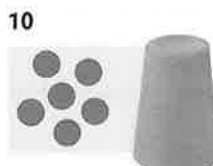

4

7 **sigui traha den bo buki di conta.**

1

split 4.

cuanto tin bou di e beker?

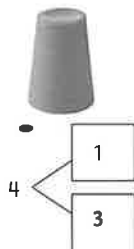
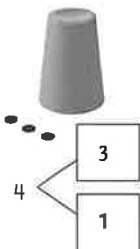
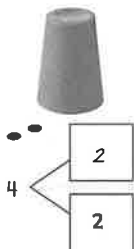

2

split 9.

cuanto tin bou di e beker?

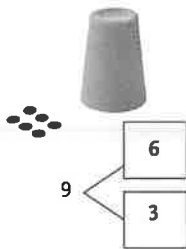
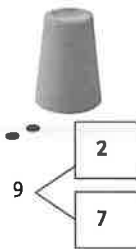
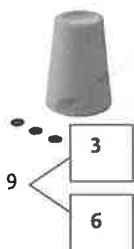
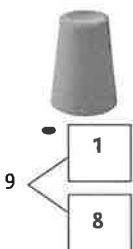
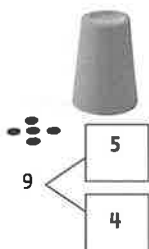

3

split 10.

cuanto tin bou di e beker?

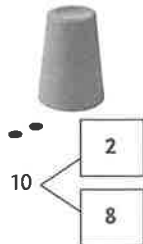
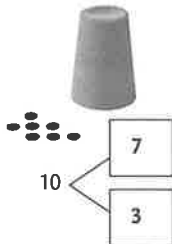
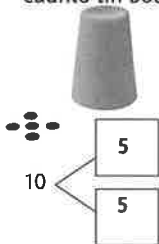

4

split 6.

cuanto tin bou di e beker?

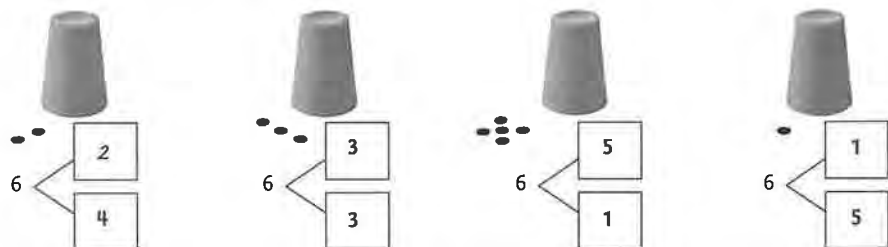

5

split.

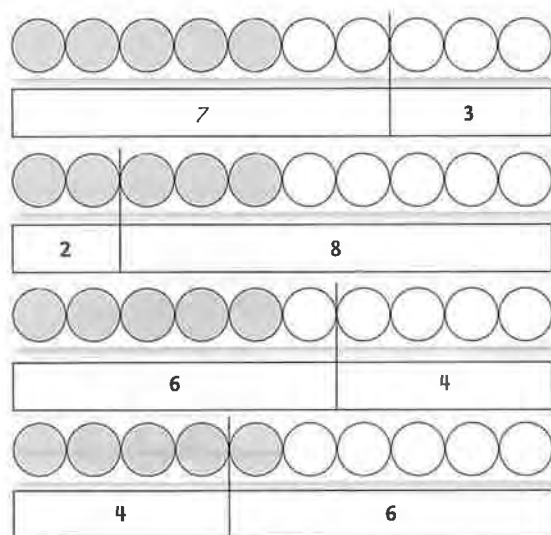

6

cuanto tin hunto?

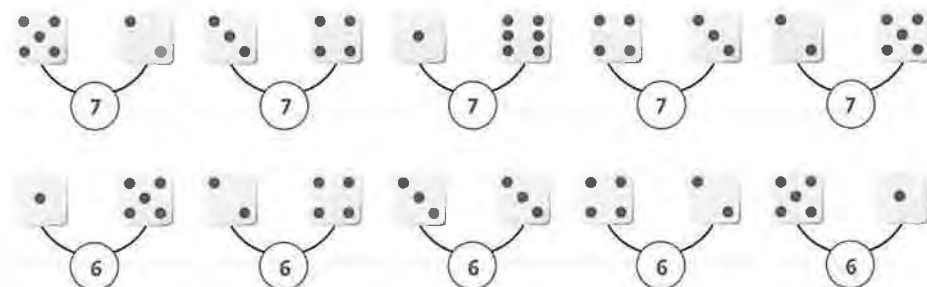

1

split.
pinta un strepi.

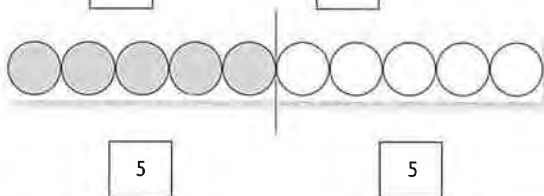
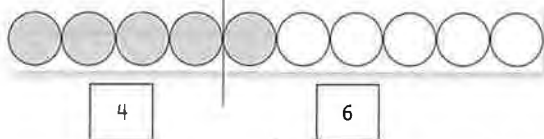
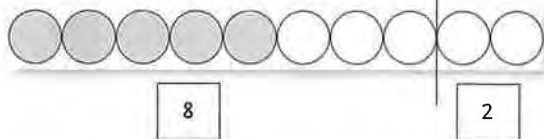

2

yena con ta split.



3

yena con ta split.



4 pinta e wowonan.

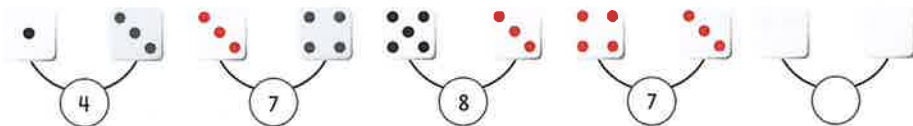

5 cuanto florin tin den e cartera?



8 florin

4

4



8 florin

6

2

6 cada cacho tin 5 yiu.
conecta cu otro.

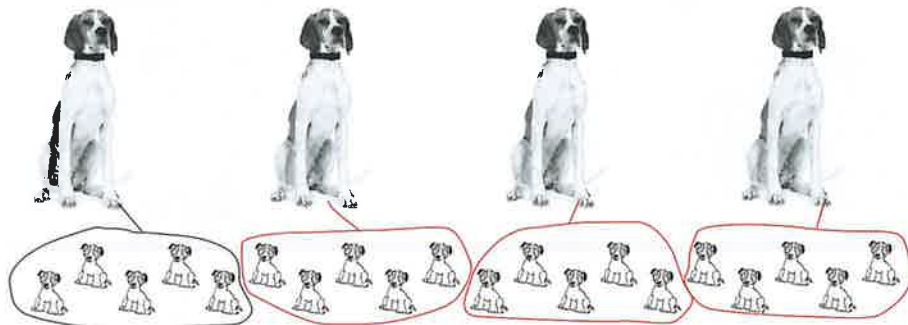

7 kleur cada biah 5 macutu.
despues traha grupo di 10.

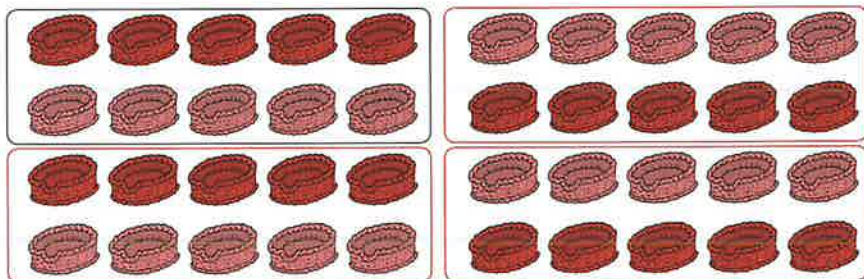

1

ban cu bus.

cuant'or e bus ta sali?

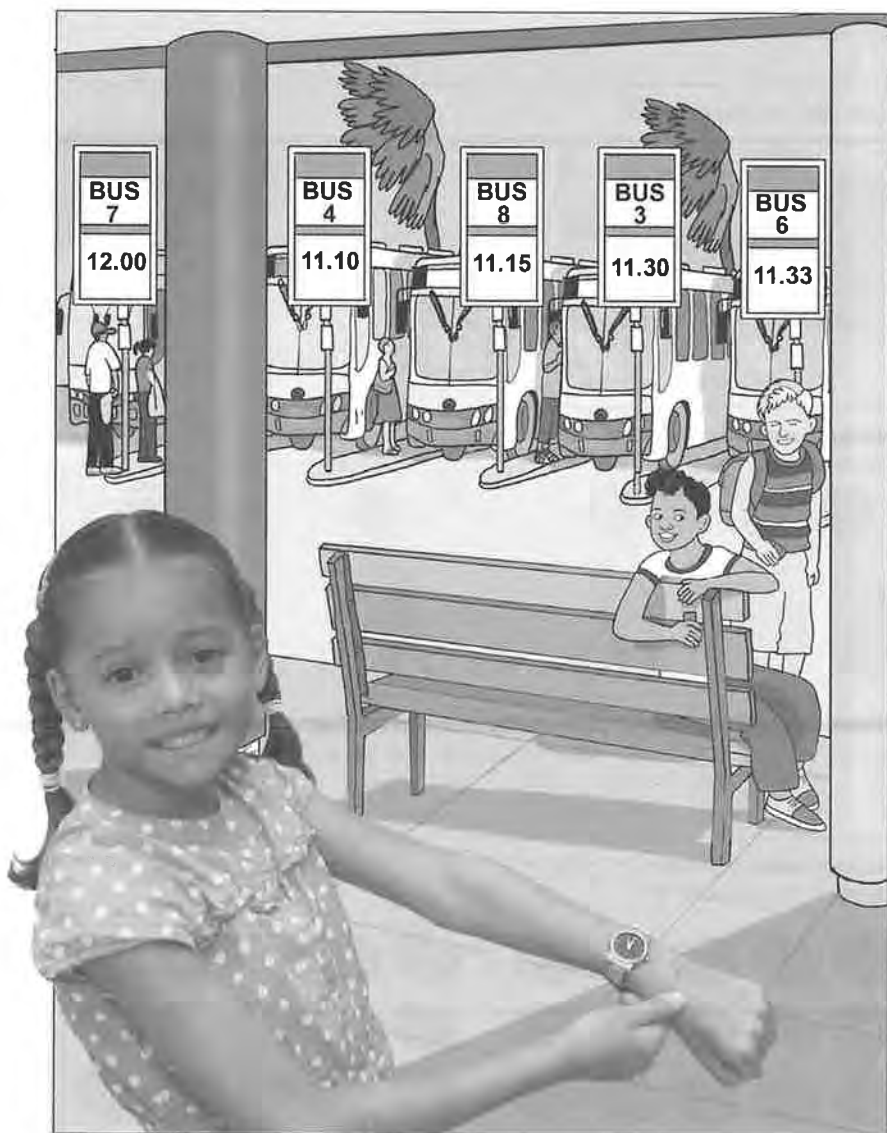

2 **cuant'or tin?**3 **cuant'or tin?**4 **unda e man chikito mester bin?**

6 or

9 or

12 or

1 or

10 or



4 or

5 or

8 or

11 or

2 or

5 **sigui traha den bo buki di conta.**

1 cuant'or tin?



9 or



1 or



4 or



7 or



3 or

2 pinta e man chikito.



3 or



6 or



5 or



11 or



8 or

3 abo mes pensa cuant'or tin.
skirbi y pinta. mas cu 1 contesta.

or



or



or



or



or



or



or



or



or



or

4 **cuant'or tin?**

10 or



7 or



5 or



3 or



1 or



11 or



8 or



2 or



4 or

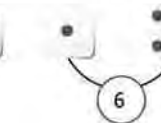
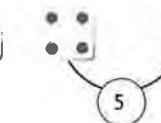

6 or

5 **pinta e wowonan.**
haci esaki na diferente manera. mas cu 1 contesta.6 **con bo por paga?**
kleur e monedanan. mas cu 1 contesta.

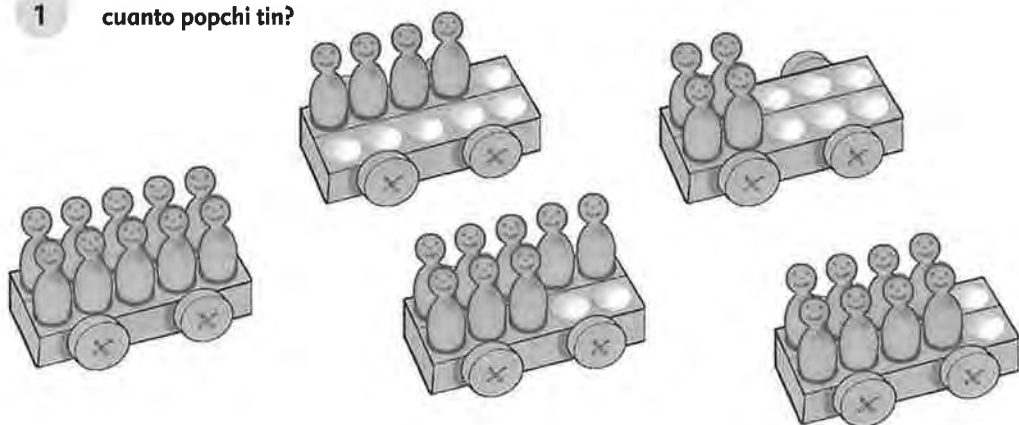
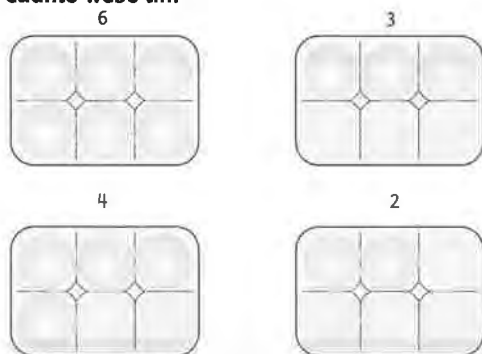
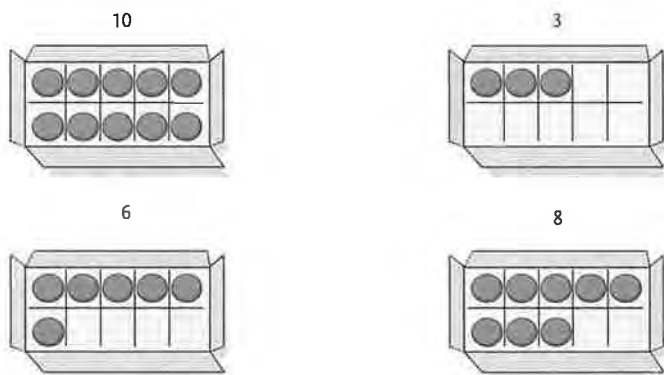
1 **cuanto popchi tin?**2 **cuanto webo tin?**3 **cuanto chuculati tin?**

4 quanto florin tin?



5 completa 10 florin.



6 sigui traha den bo buki di conta.

1 cuanto webo tin den e caha?

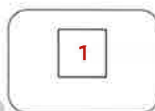
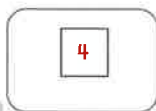
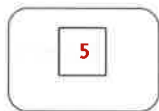
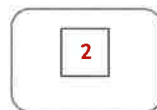
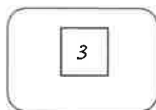

2 cuanto cuki tin den e caha?

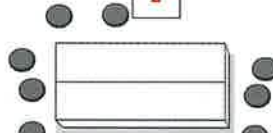
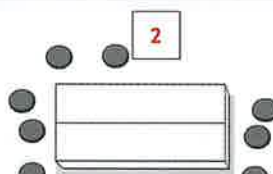
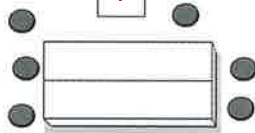
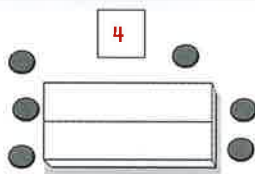
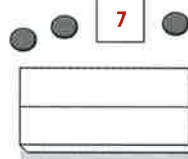
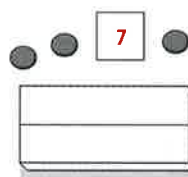
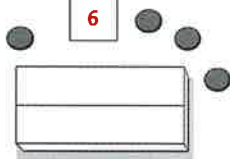
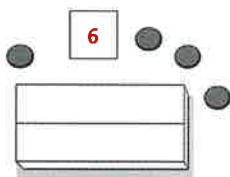
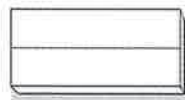
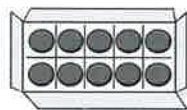
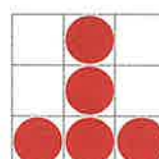
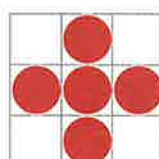
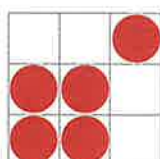
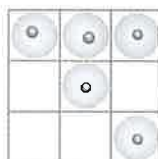
3 tin 5 bolo den e caha.
pone nan na otro manera. mas cu 1 contesta.

- 4 pone na otro manera.
mas cu 1 contesta.

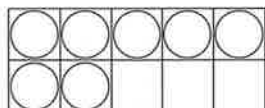

7

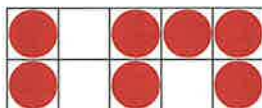

7

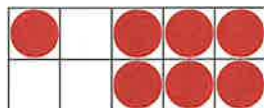

7

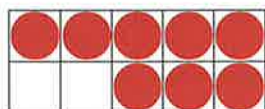

8

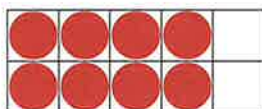

8

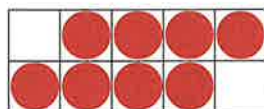

8

- 5 cuanto tin hunto?

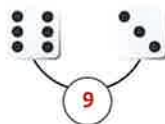
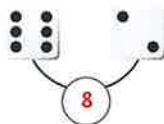
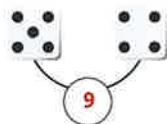
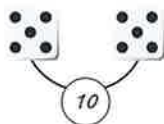

- 6 pinta e wowonan.

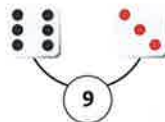
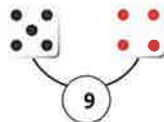
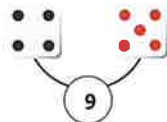
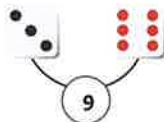

- 7 pinta e man chikito.



7 or



9 or



5 or



3 or



1 or



10 or



2 or



6 or



4 or



8 or

1 **cuant'or tin?**

2 or



8 or



10 or



5 or



12 or

2 **cuant'or tin?**

11 or



6 or



2 or



8 or

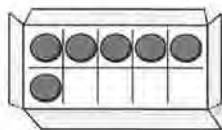
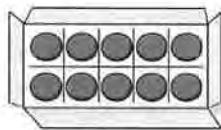

3 or

3 **yena e caha.**
cuanto cuki mester pone acerca?

4

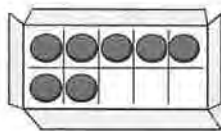

3

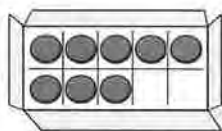

2

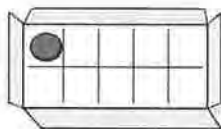

9

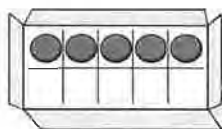

5

4 split 9.
cuanto tin bou di e beker?

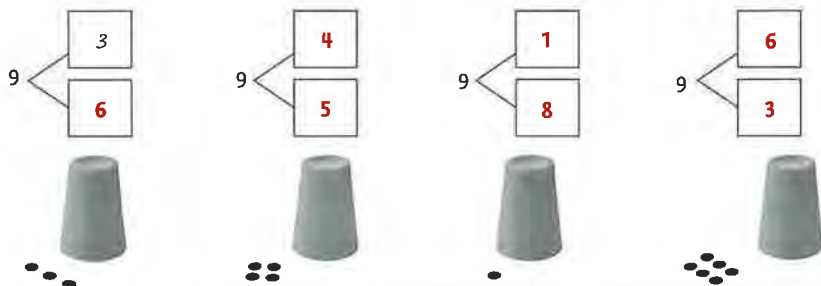

5 cuanto tin hunto?

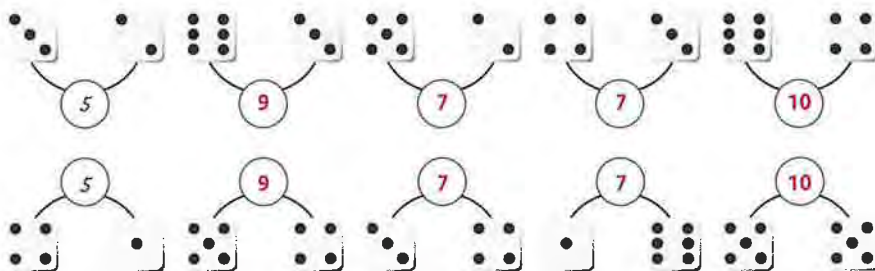

6 split 6.

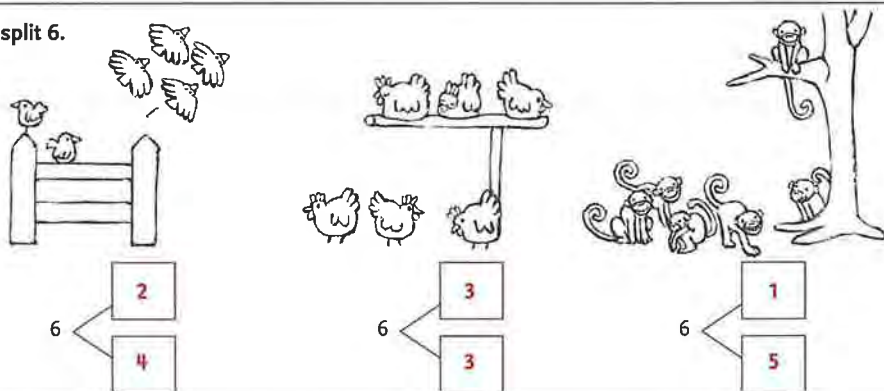

7 con abo ta sigui kleur?



1 conta.

1 2 3 4 5 6 7 8 9 10

2 conta bay bek.

10 9 8 7 6 5 4 3 2 1

3 conta cu salto di 2.

2 4 6 8 10

1 3 5 7 9

4 conta bay bek cu salto di 2.

10 8 6 4 2

9 7 5 3 1

5 traha grupo di 5.



6 conecta cu otro.

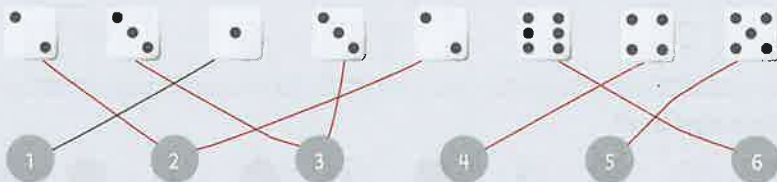

7 conecta cu otro.

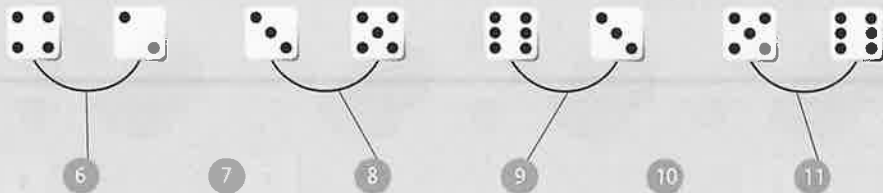

8 conecta cu otro.

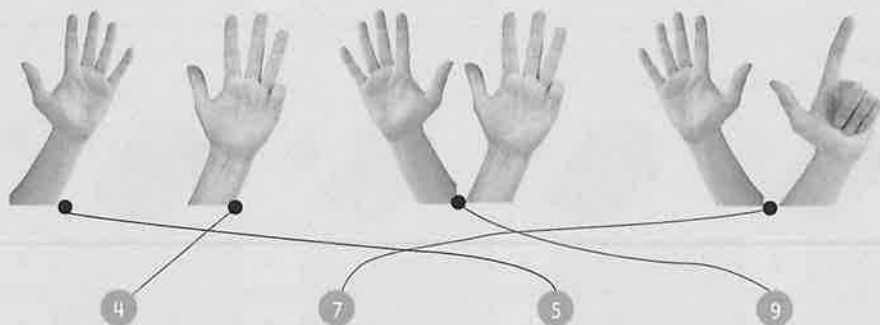

9 conecta cu otro.

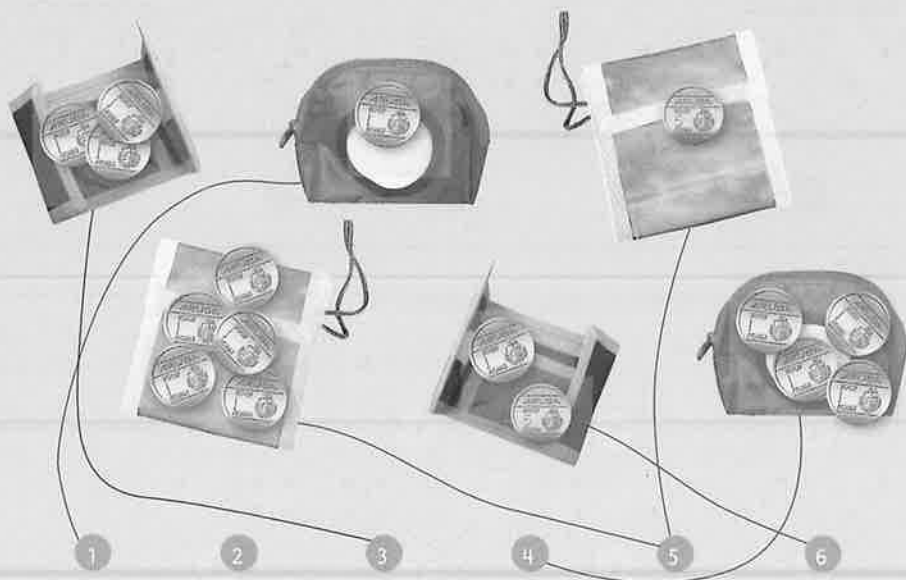

- 1 **split 8.**
cuanto tin bou di e pechi?

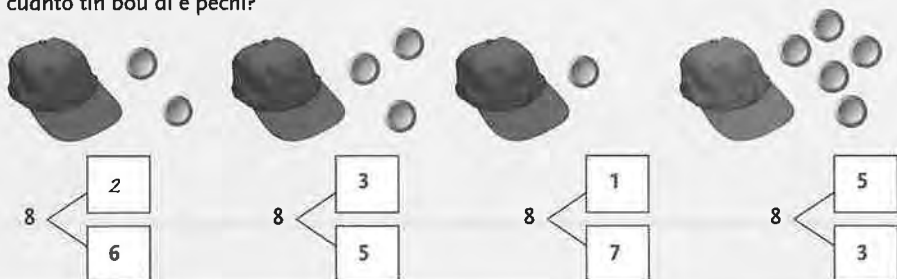

- 2 **splits 7.**
cuanto tin bou di e pechi?

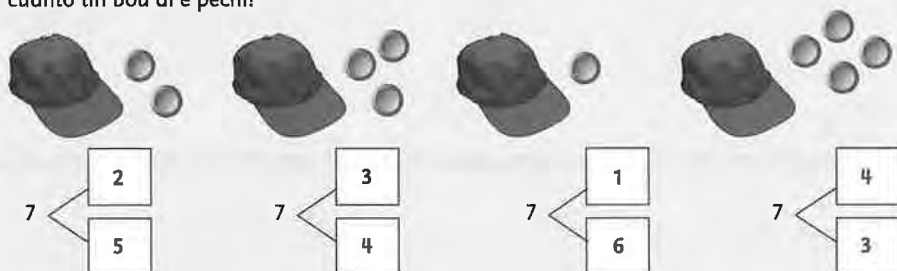

- 3 **conecta cu otro.**

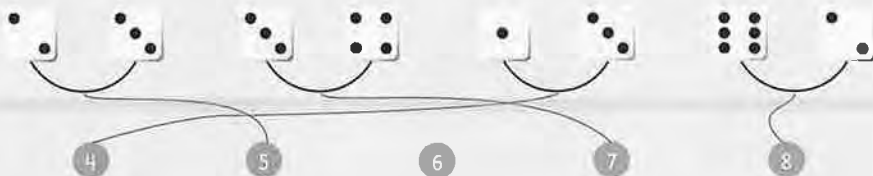

- 4 **pinta e wowonan.**
haci esaki na diferente manera. mas cu 1 contesta.

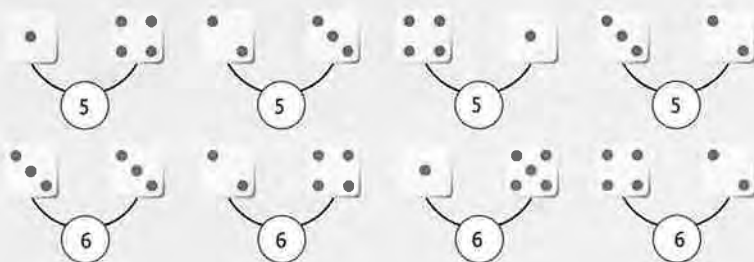

5 **cuant'or tin?**

2 or



8 or



10 or



5 or



7 or

6 **cuant'or tin?**

1 or



9 or



6 or



12 or



5 or

7 **pinta e man chikito.**

2 or



12 or



4 or



8 or



5 or

8 **pinta e man chikito.**

11 or



7 or



3 or



1 or

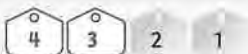
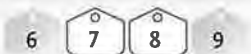
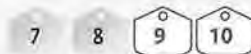
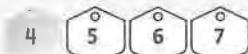

6 or

9 **yena e numbernan.**

60

blok 2

plus

1 completa e rij.

3

6

9

12

15

18

21

24

2 pinta e wowonan.
haci esaki na diferente manera.
bo ta logra?



3 cuanto tin hunto?



4 cua prinses por yega cerca e prins?

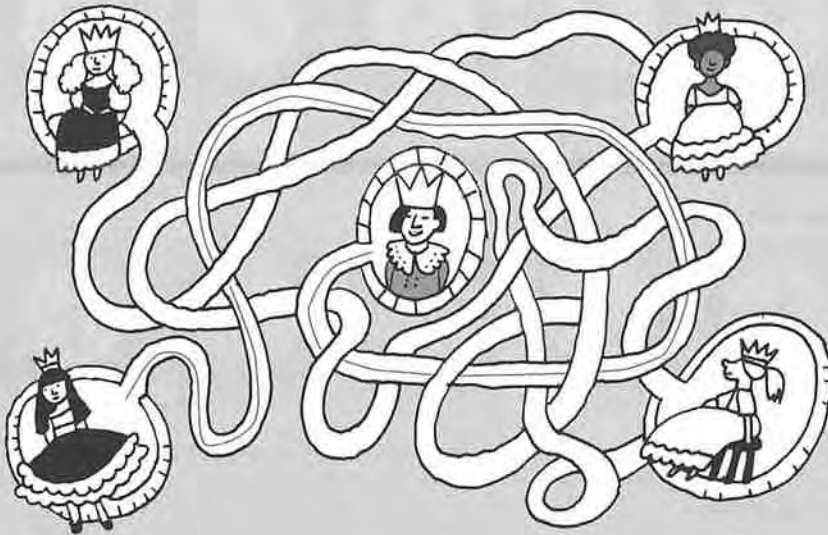

5 pinta e ruta corecto.

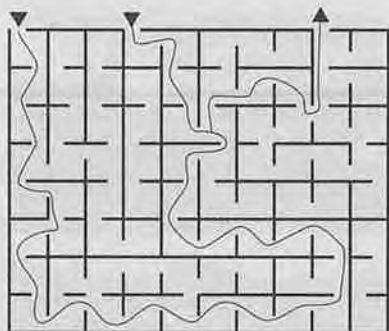

6 completa e rij.

1

10

3

8

5

6

7

4

9

2

7 abo mes pensa cuant'or tin.
skirbi y pinta.





















8 paga 10 florin.
pinta e placa cu 2 moneda.



pinta e placa cu 6 moneda.

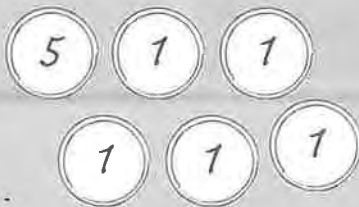

1 cuant'or tin?

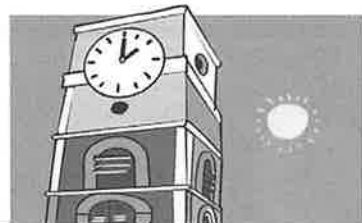

2 cuant'or tin?



3 **cuant'or tin?**4 **mas tempran y mas laat.**

a 1 ora mas tempran.

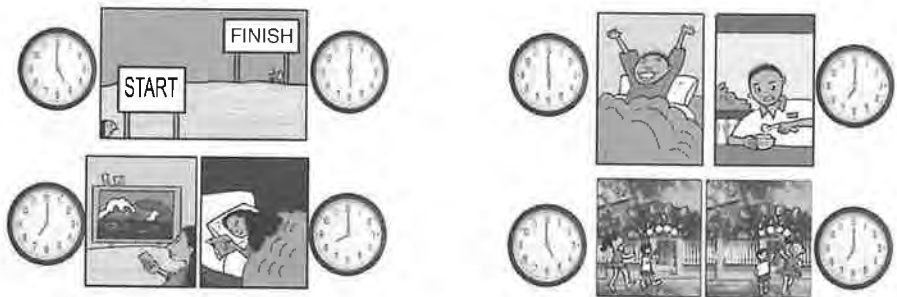

b 1 ora mas laat.

5 **cuanto tempo a pasa?**6 **sigui traha den bo buki di conta.**

2

blok 2

les 17

1 pinta e man chikito.



6 or



7 or



9 or



10 or



3 or



5 or



6 or



7 or



8 or

2

1 ora mas tempran.

pinta e man chikito.



3 1 ora mas laat.
pinta e man chikito.



4 split 8.
kleur e ronchinan y yena e numbernan.

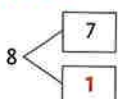
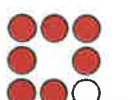
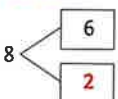
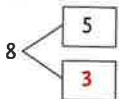
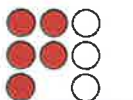
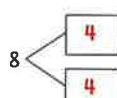
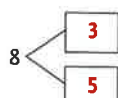
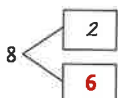
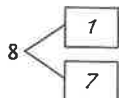

5 pinta e wowonan. mas cu 1 contesta.

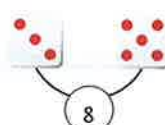
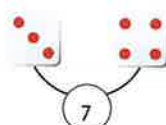
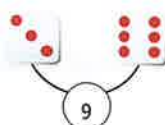
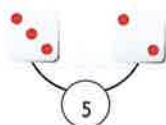
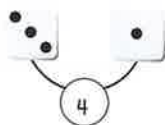

1 un repi di 10.

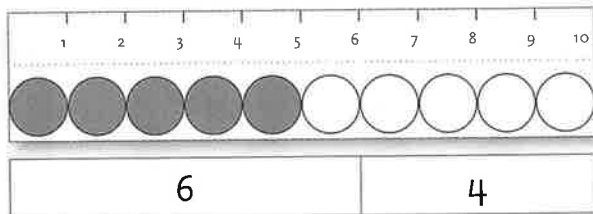

2 con largo cada pida ta?

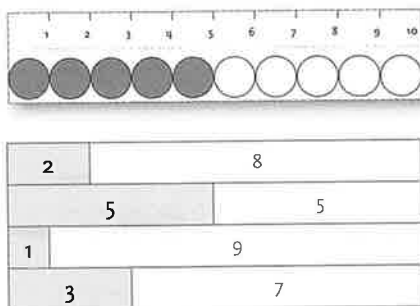
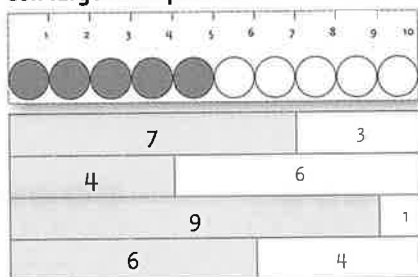

3 con largo cada pida ta?

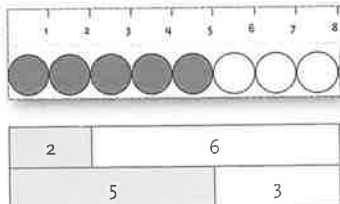
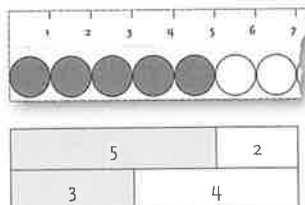
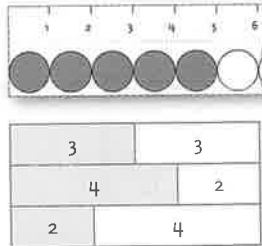
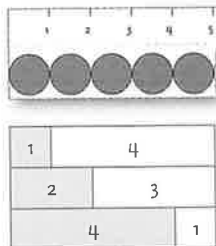
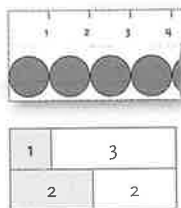
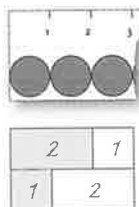

4 con largo cada pida ta?

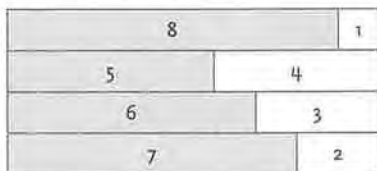
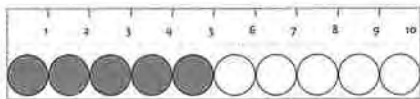
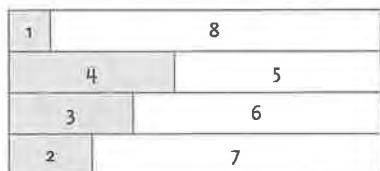
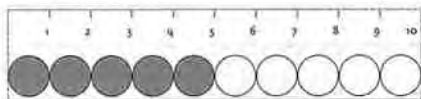

5 con largo e pida memey ta?

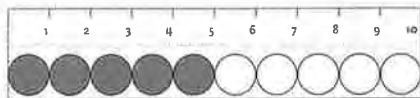
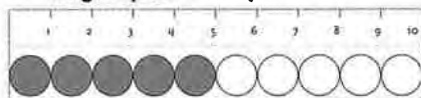

6 con largo cada pida ta?



1 con largo cada pida ta?



2	8	
4		6
1	9	
7		3



3	7	
6		4
5		5
8		2

2 con largo e pida memey ta?



2	4	4
3	2	5
2	6	2



1	8	1
7		2
4	5	1

3 con largo cada pida ta?



1	4
3	2
2	3



2	5
4	3
6	
1	



3	3
1	5
4	2



4	4
2	6
5	3



3	6
4	5
6	3



5	5
3	7
6	4

4 con largo cada pida ta?

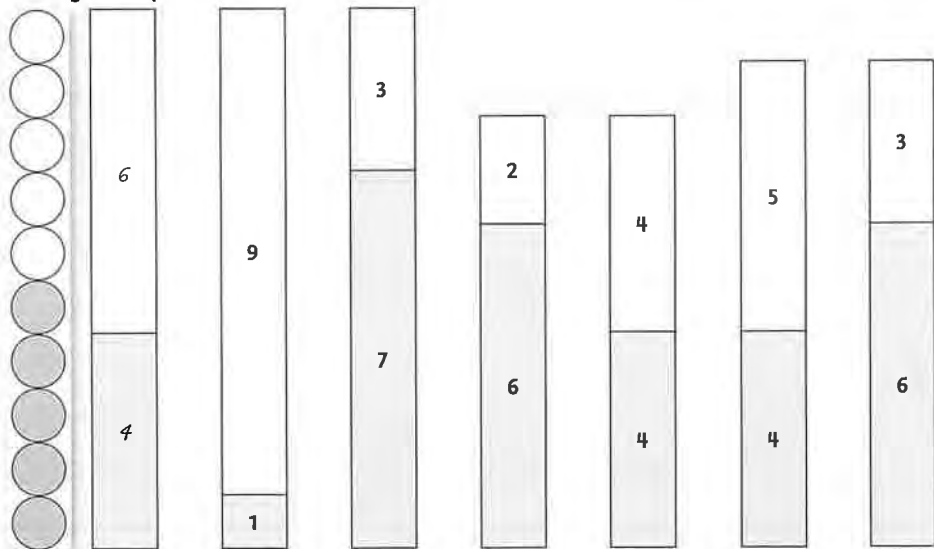

5 split. cuanto ficha tin bou di e pechi?

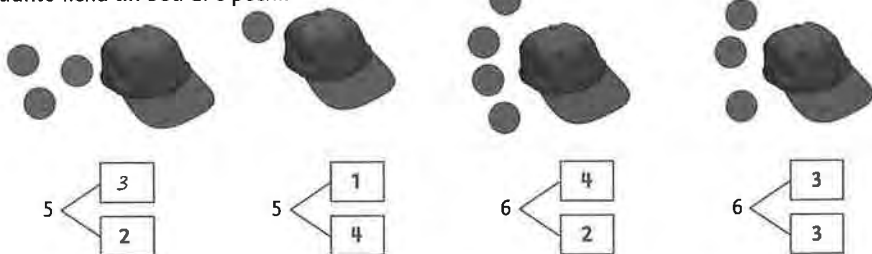

6 con bo ta split?

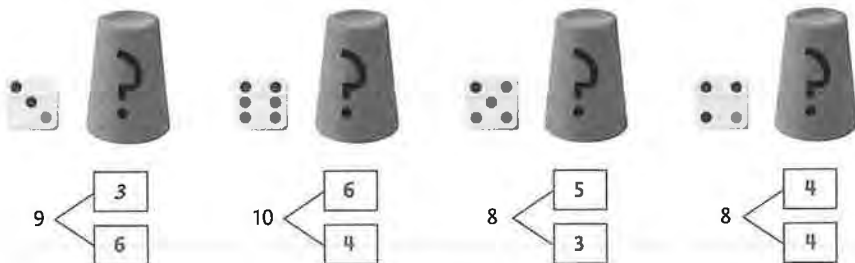

1

1 ora mas tempran.

conecta cu otro.

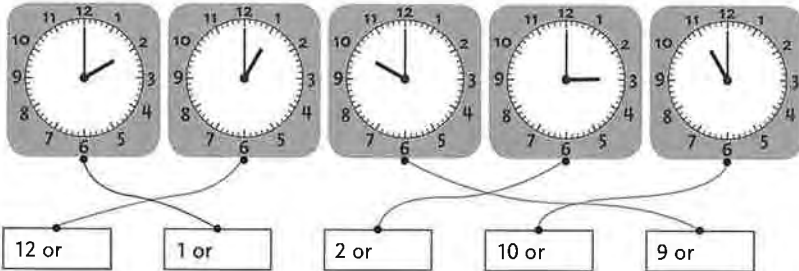

2

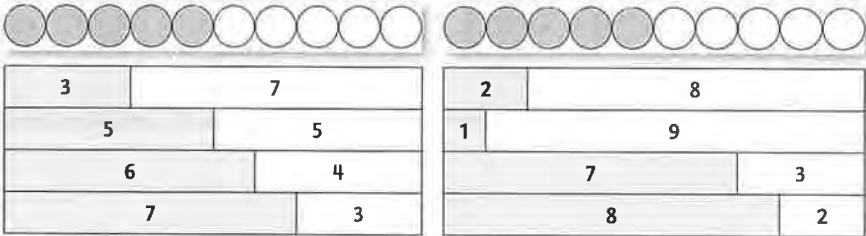
con largo cada pida ta?

3

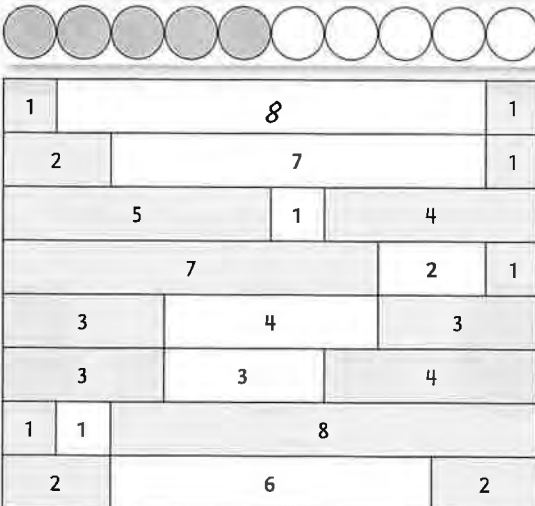
con largo e pida memey ta?

4 split 7.

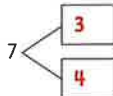
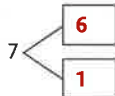
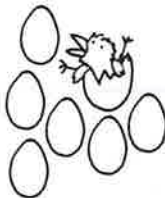
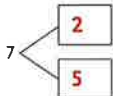
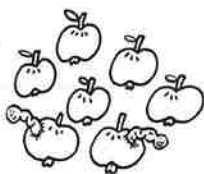
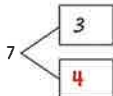

5 split 8.

kleur e ronchinan y yena e numbertan.

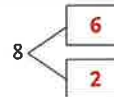
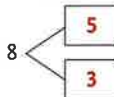
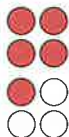
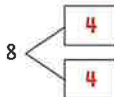
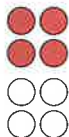
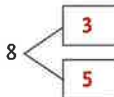
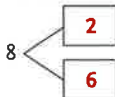
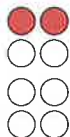
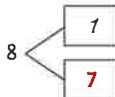
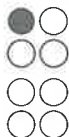

6 cua di nan ta mes hopi?

conecta cu otro.

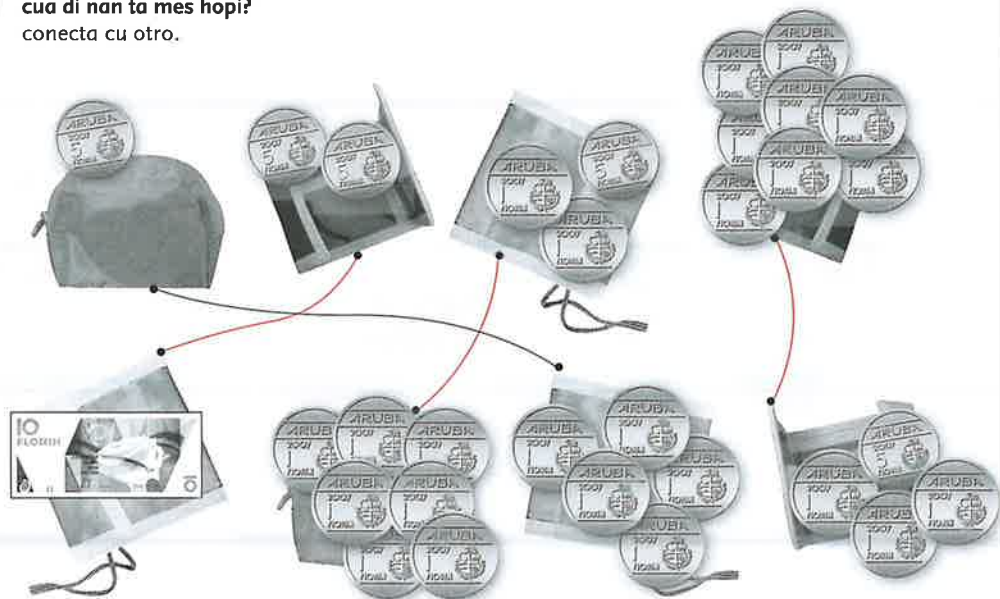

1 paga na diferente manera.



2 paga na diferente manera.

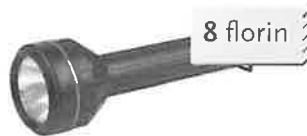

3 cuanto placa bo ta haya bek?

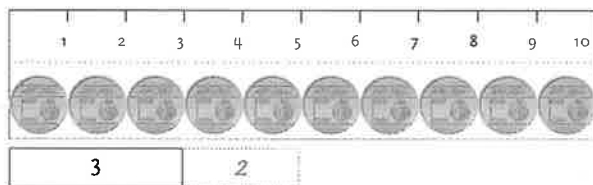

3 florin



4 florin



7 florin



8 florin



4 cuanto nan ta costa hunto?

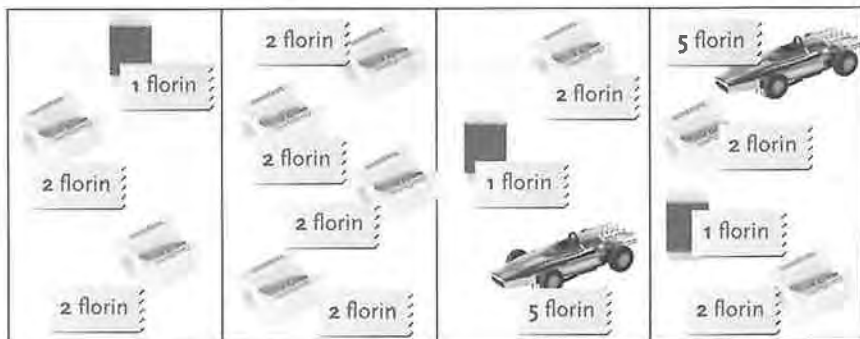

5 con bo ta paga?

paga 6 florin cu 6 moneda.

paga 7 florin cu 3 moneda.

paga 6 florin cu 2 moneda.

paga 10 florin cu 10 moneda.

paga 9 florin cu 9 moneda.

paga 10 florin cu 2 moneda.

paga 9 florin cu 5 moneda.

paga 10 florin cu 6 moneda.

6 cuanto florin tin?

a 2 florin mas.



b 2 florin menos.



1 kleur e monedanan cu bo ta uza.

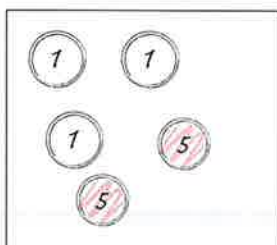
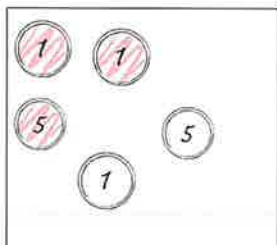
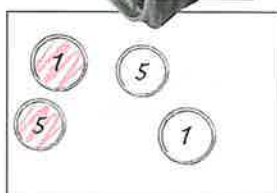
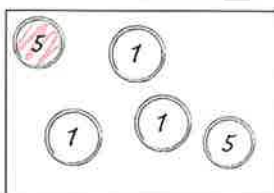
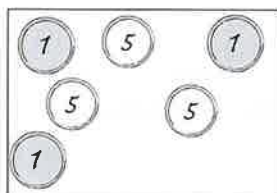

2 tin mas, menos of mes hopi?
kleur e contesta.



mas
menos
mes hopi



mas
menos
mes hopi



mas
menos
mes hopi

- 3 completa 10 florin.
pinta e monedanan cu falta.

mas cu 1 contesta.

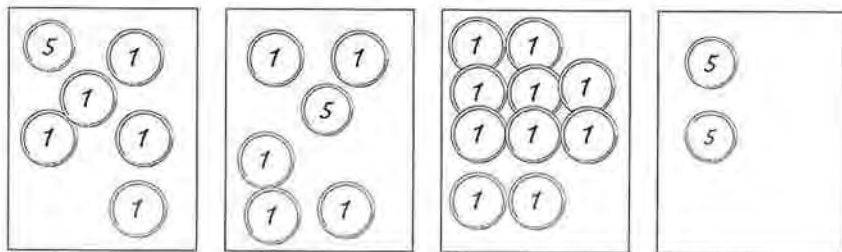

- 4 yena e numbernan.

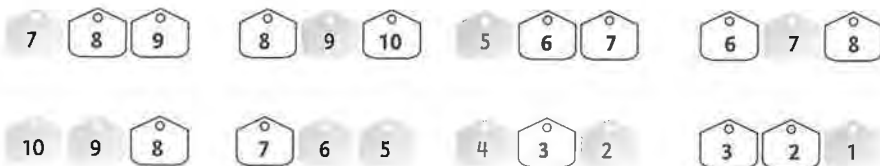

- 5 pinta e wowonan. mas cu 1 contesta.

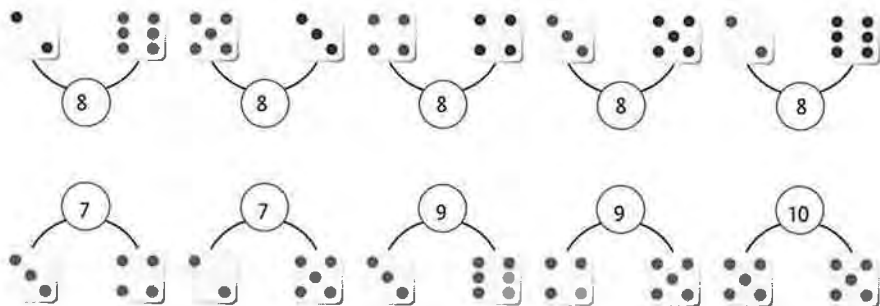

1 con yen e ta?



2 wak y conta.

a con yen e ta?

b cuanto mas bo por yena?

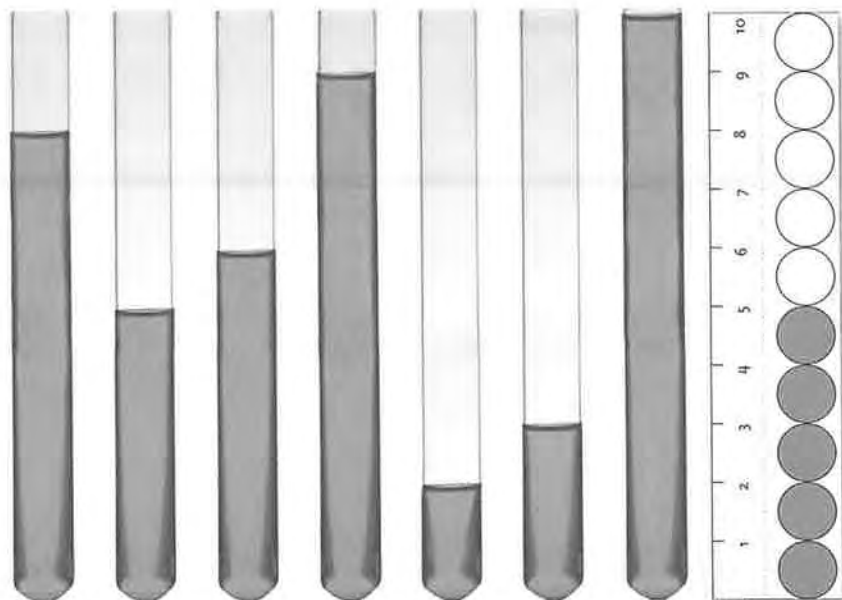

3 midi e piscanan.

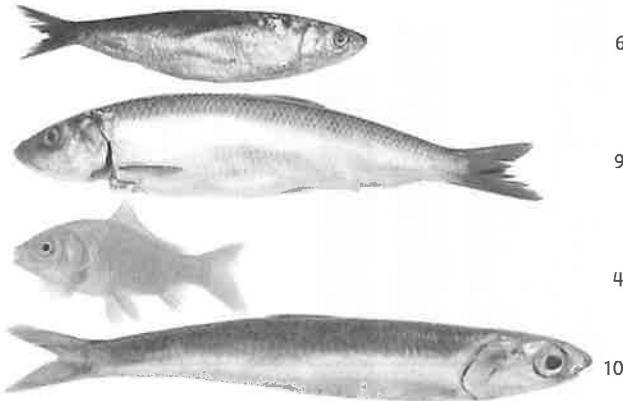
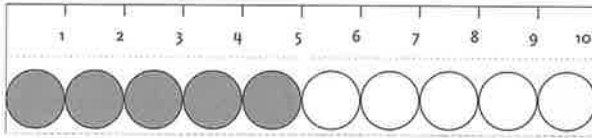

4 midi tur e bandanan.

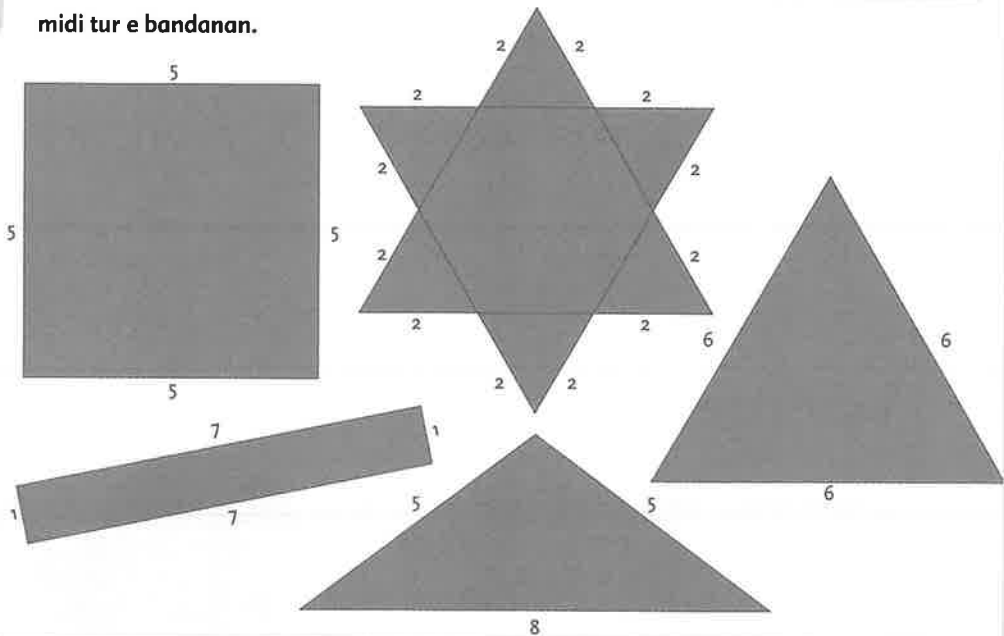

5 sigui traha den bo buki di conta.

1 con yen nan ta?

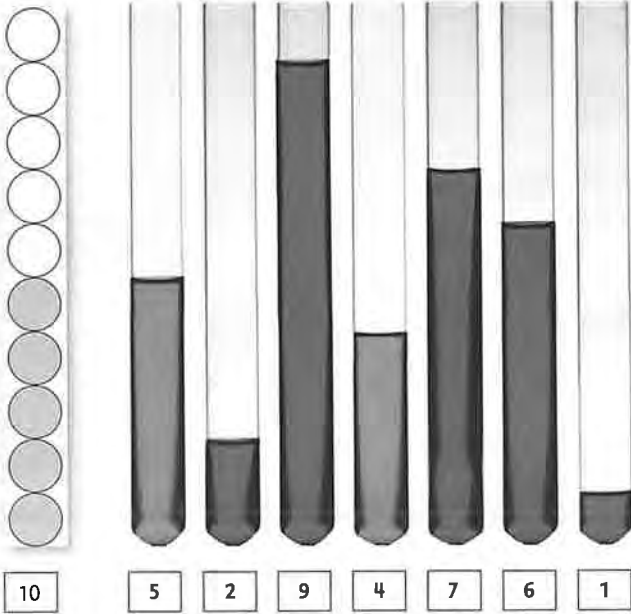

2 midi e cocolishinan.



3 pinta drop.



3

5

7

4



4 split 10.

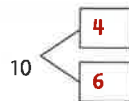
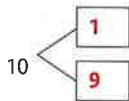
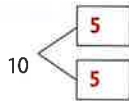
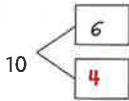
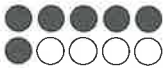

5 split 9.

kleur e ronchinan y yena e numbertan.

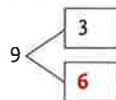
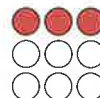
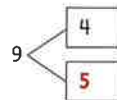
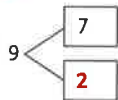
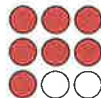
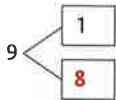
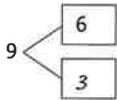

6 1 ora mas tempran.

pinta e man chikito.



1 **cuanto nan ta costa?**
kleur ken ta paga mas.



vic
5 florin



eva
6 florin



tico
8 florin

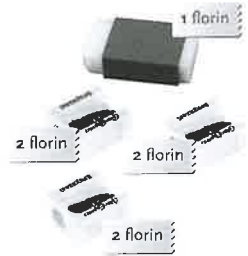

lisa
7 florin

2 **con ta split e repinan?**

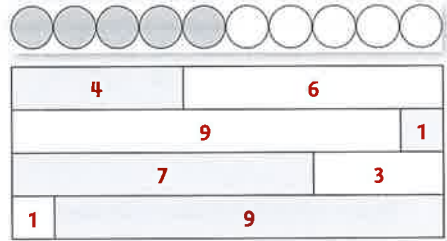
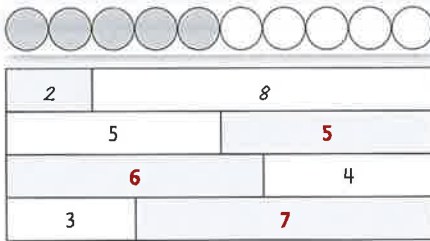

3 **pinta y kleur e torennan.**

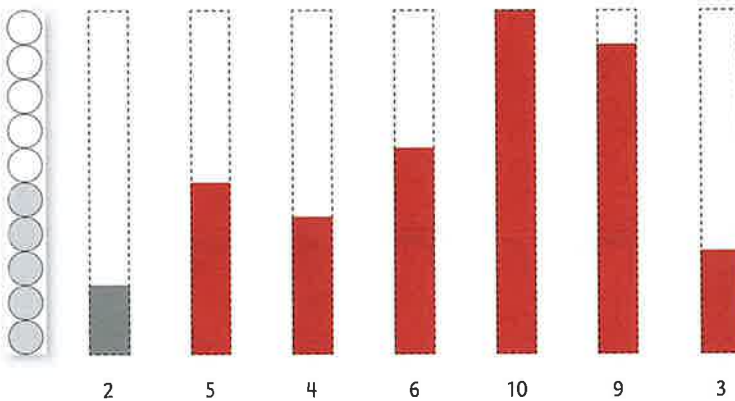

4 con ta split e repinan?

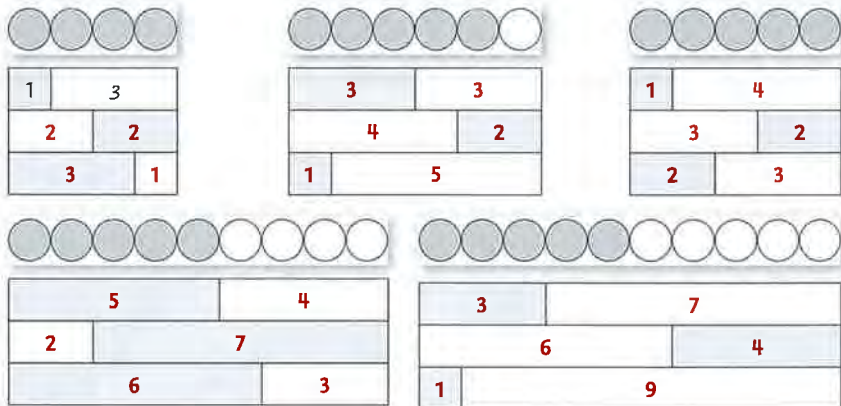

5 split 7.
kleur e ronchinan y yena e numbertan.

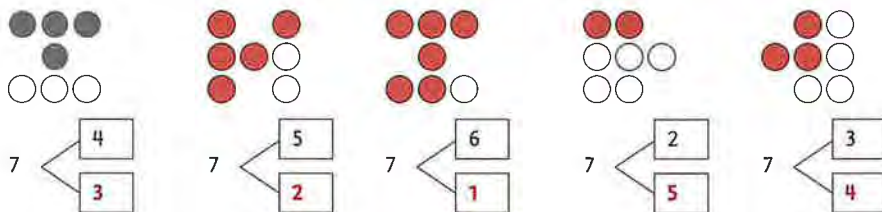

6 pinta e wowonan.

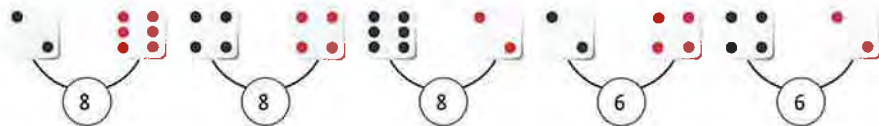

7 completa e rijnan.



14

blok 2

den un rato

1 yena e numbertan.



2 completa e rijnan.

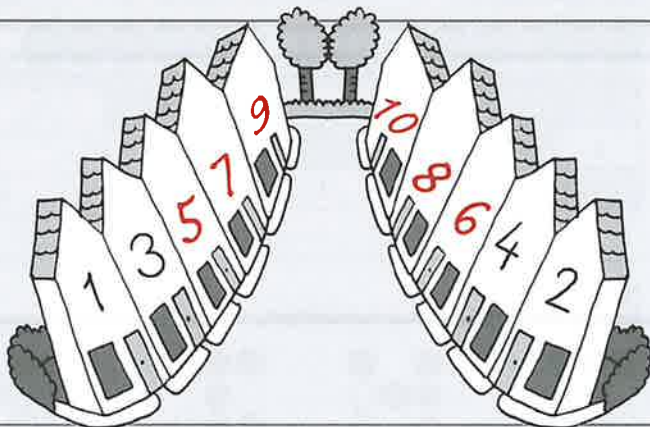

3 cuanto nan ta costa?



4



6



5



9

4 split 9.

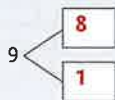
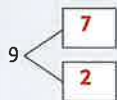
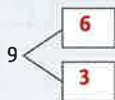
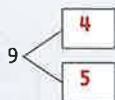
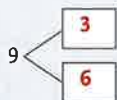
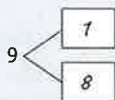

5 cuanto tin?



4



7



8



9

6 con ta split esakinan?

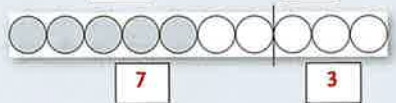

7 cuanto tin hunto?

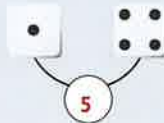
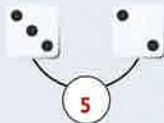
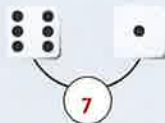
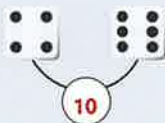

8 split 10.

kleur e ronchinan y yena e numbernan.

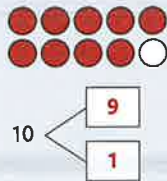
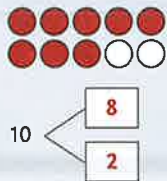
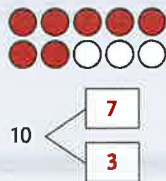
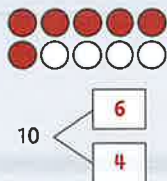
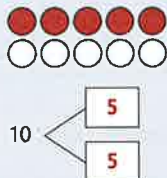
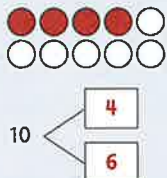
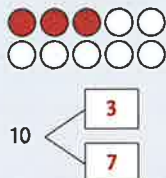
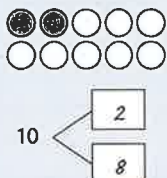

- 1 1 ora mas laat.
conecta cu otro.

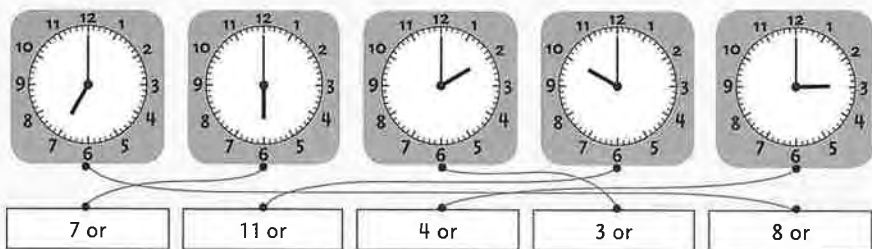

- 2 cua number ta pas memey?

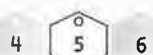
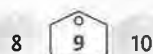
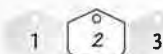

- 3 cuanto tin hunto?

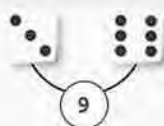
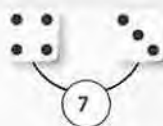
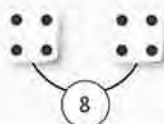
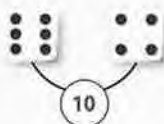

- 4 conecta cu otro.

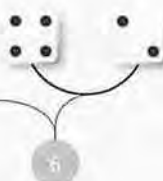
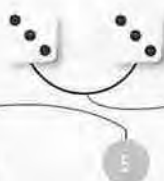
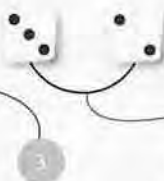

5 con ta split esakinan?

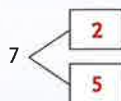
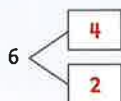

6 con ta split e balanan?

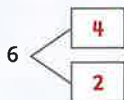
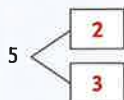

7 pinta e latanan.



4



5



8



9



1

cuanto pida tin den henter e puzzel?

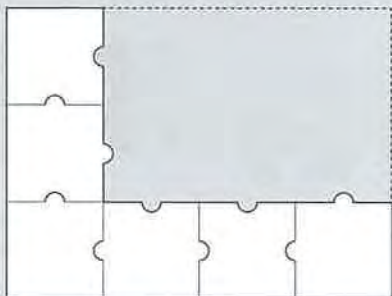

12 pida

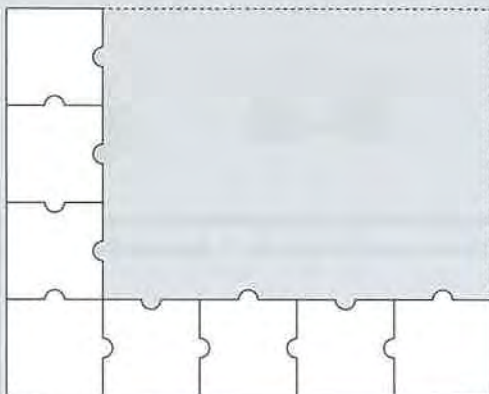

20 pida

2

cuanto bleki tin den e caha?

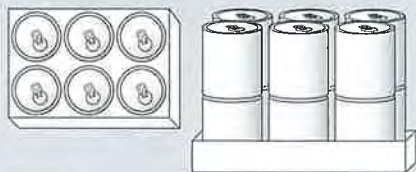

12 bleki

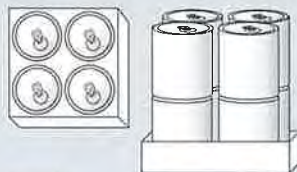

8 bleki

3

kleur e hokinan cu hunto ta forma 10.
kleur menos hoki posibel.

1	1	2
1	5	3
2	1	5

1	6	3
4	1	2
1	3	2

1	6	3
2	1	4
2	3	1

4

kleur e hokinan cu hunto ta forma 12.
kleur menos hoki posibel.

mas cu 1 contesta.

6	1	2
3	2	3
2	1	7

1	6	3
1	1	4
2	3	6

1	2	3
4	5	6
7	8	9

5 hunto nan ta forma e number bou di e saco. mas cu 1 contesta.



5



4



6



10

6 split den 3 pida.
haci esaki na diferente manera. mas cu 1 contesta.



1	1	4



7 pinta e ruta corecto.

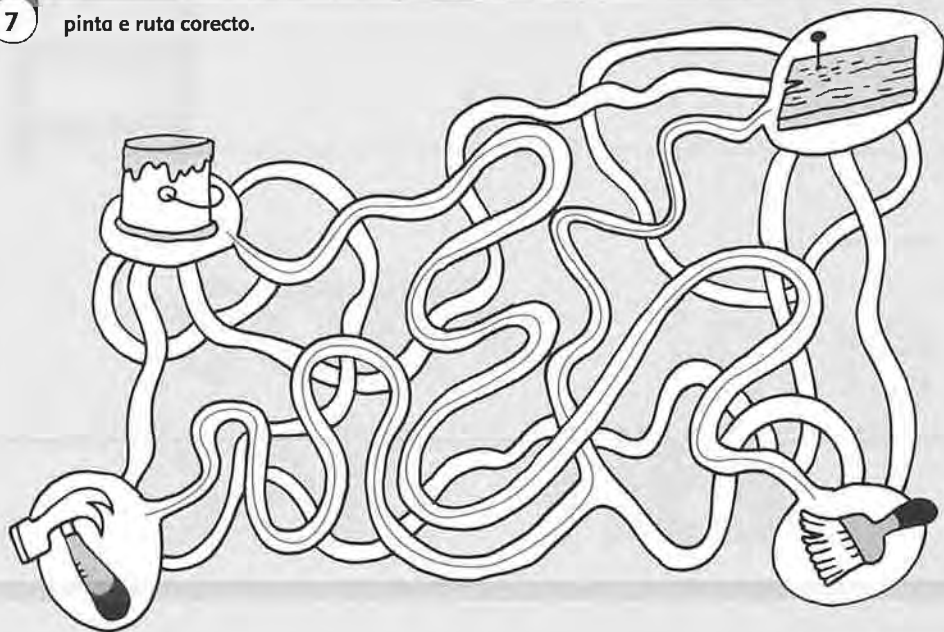

1 uza spiel pa haci completo.



2 uza spiel pa haci mas cortico of mas largo.

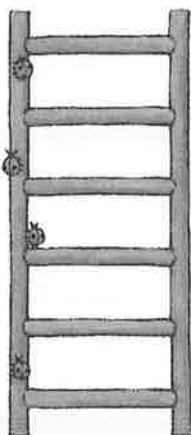
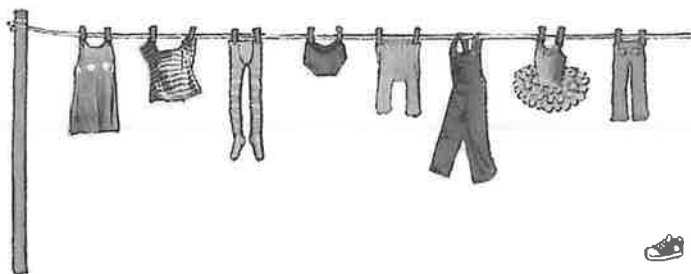

3 uza spiel pa lesa.

pen
rita
sam
lena

4 **haci mescos cu tica.**



traha hopi ficha cora.



cuanto bo ta mira awor?

5 **cuanto ficha bo por traha?**



6 **cuanto ficha bo por traha?**



7 **bo tin 5 ficha.**
uza spiel pa traha mas.



- 1 uza spiel.
pinta y kleur.

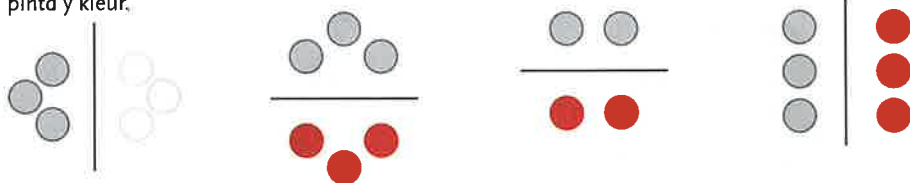

- 2 uza spiel y pinta.

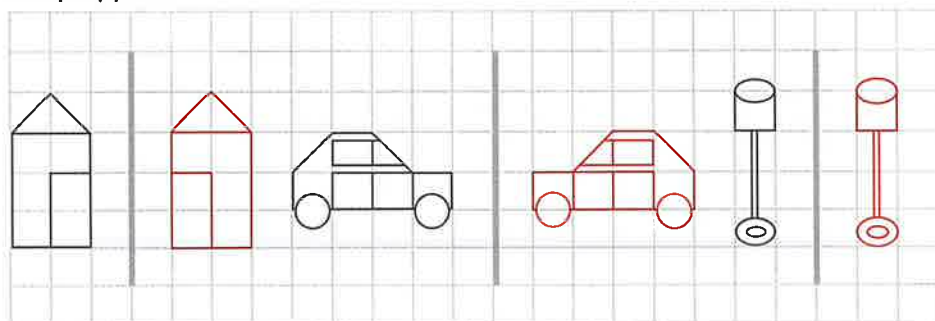

- 3 uza spiel y completa e figuranan aki.

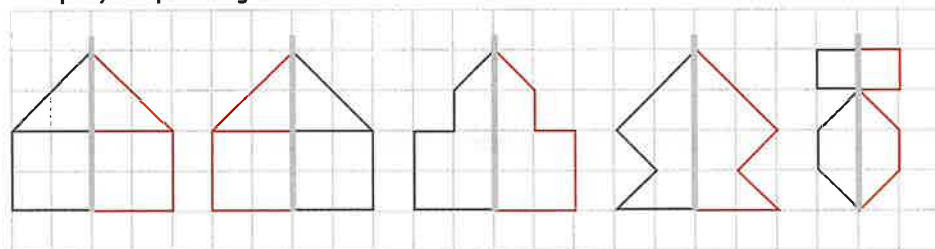

- 4 pinta y uza spiel.
pensa cada figura pa bo mes.

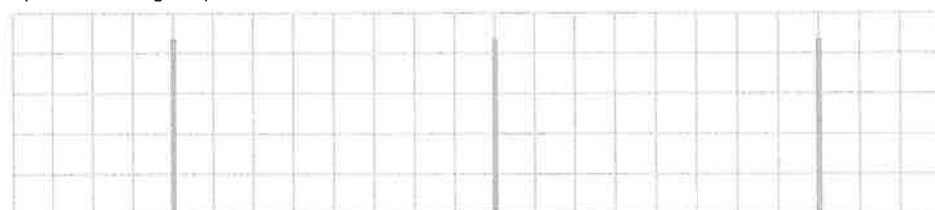

5 uza spiel y pinta.

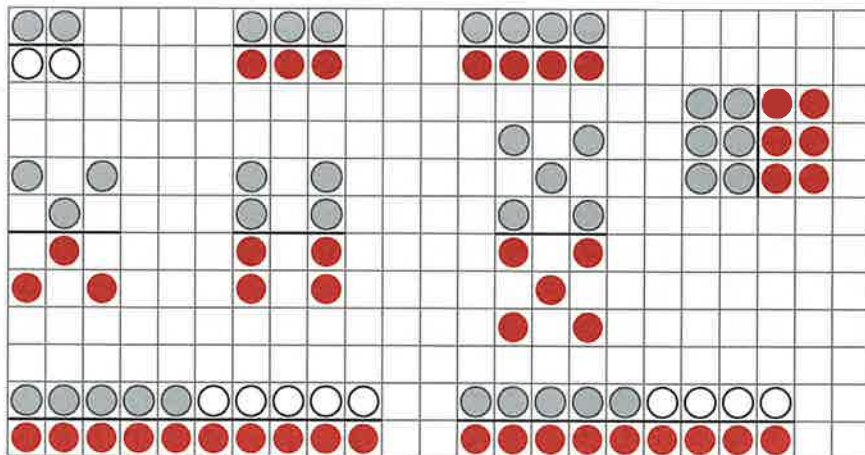

6 split 6.
kleur e ronchinan y yena e numbertan.

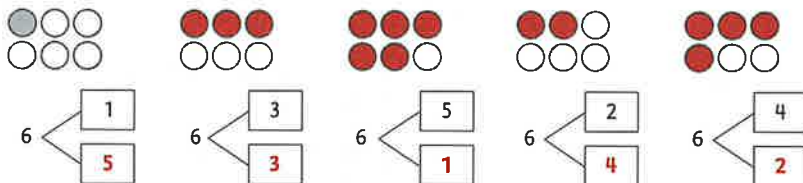

7 cuanto tin hunto?

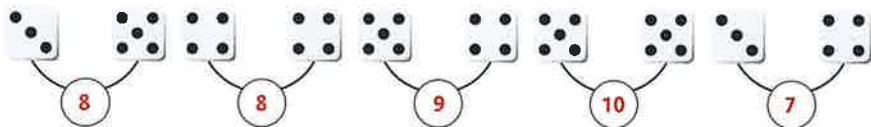

8 pensa pa bo mes.

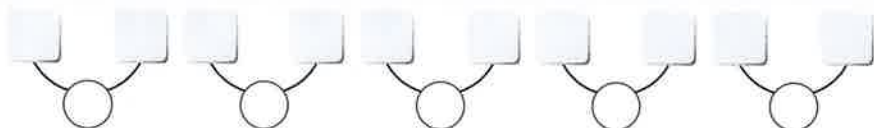

















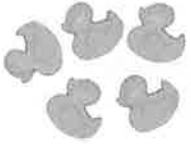
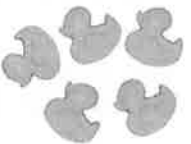



1 cuanto pisca tin?

	11	
	12	
	13	
	14	
	15	
	16	
	17	
	18	
	19	
	20	

2

cuanto tin?

con bo ta conta nan?

			12
			13
			16
			14
			19
			18
			17

3

sigui traha den bo buki di conta.

1

cuanto tin?

kleur mes hopi.

skirbi.

		12
		15
		13
		14
		11
		18

2

conecta cu otro.

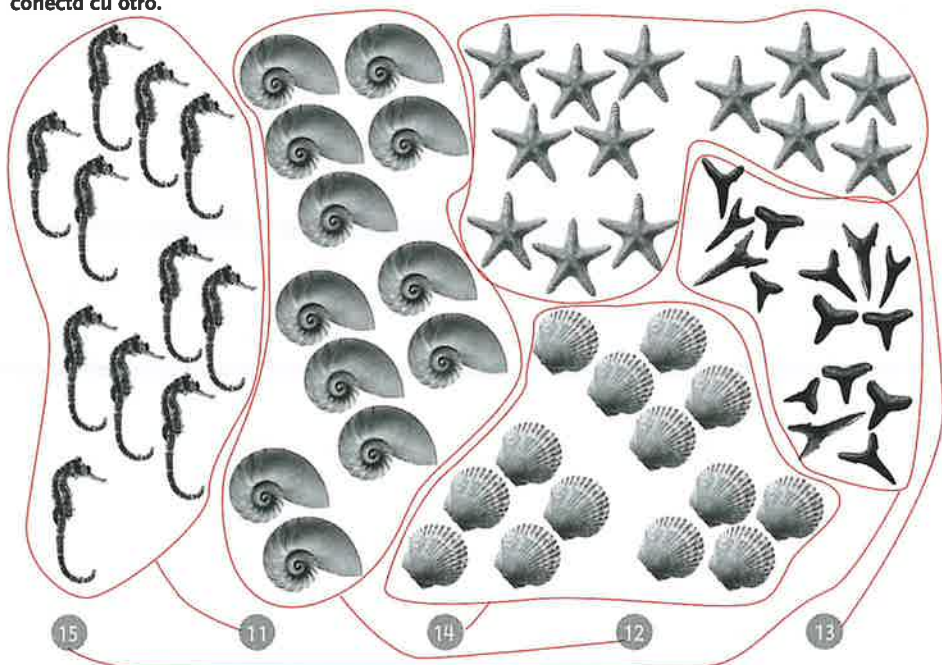

- 3 **cada biala 3 ora mas laat.**
pinta e man chikito y yena e ora.



1 or



4 or



4 or



7 or



7 or



10 or



10 or



1 or

- 4 **cada biala 3 ora mas tempran.**
pinta e man chikito y yena e ora.



12 or



9 or



9 or



6 or



6 or



3 or



3 or



12 or

1 **cuanto ronchi tin hunto?**

kleur cada biaha 5.
despues traha grupo di 10.

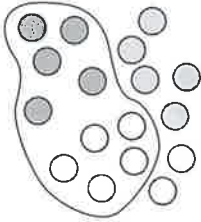

17

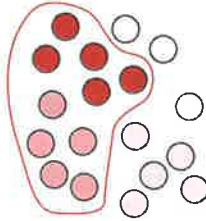

18

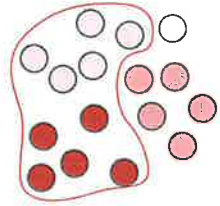

16

2 **cuanto tin?**

kleur mes hopi.

skirbi.

		12
		14
		17
		16
		13

3 **skirbi e numbernan.**



4 split 4 y 5.

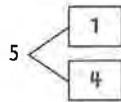
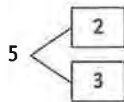
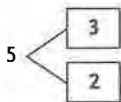
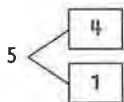
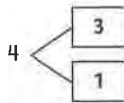
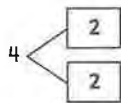
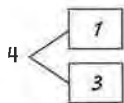

5 split 8.

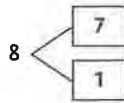
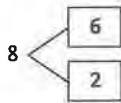
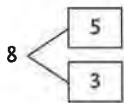
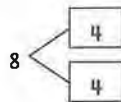
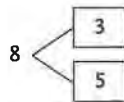
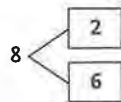
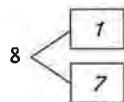

6 cuanto tin hunto?

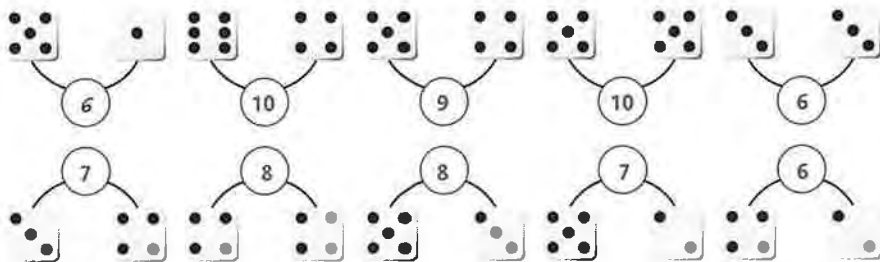

7 pinta e man chikito.



6 or



3 or



9 or



12 or



4 or

1 kico bea y nico ta haci?

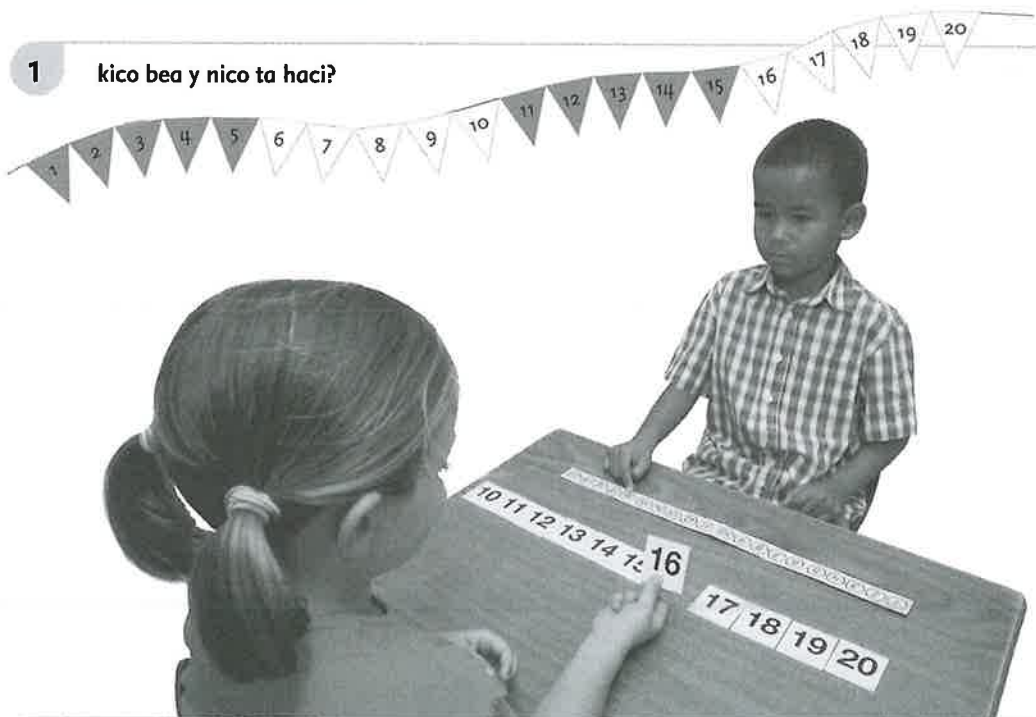

2 con bo ta sigui conta?



3 traha pa bo mes.
pone cada number na su luga.



4 **sigui conta of conta bay bek.**

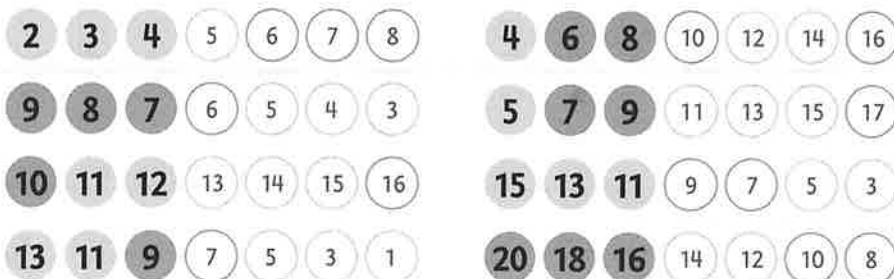

5 **cua number falta?**



6 **mas tempran y mas laat.**

cuant'or tin?

cuant'or tabatin 1 ora pasa?

cuant'or tin aki 1 ora?



7 **sigui traha den bo buki di conta.**

1

conecta cu otro.

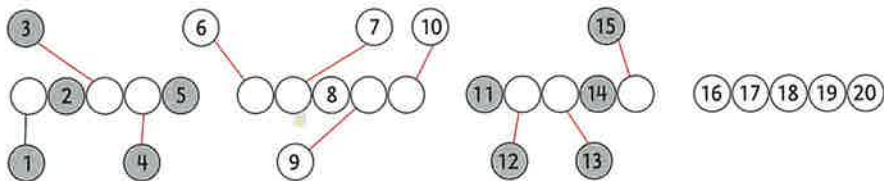

2

cua number ta pas?

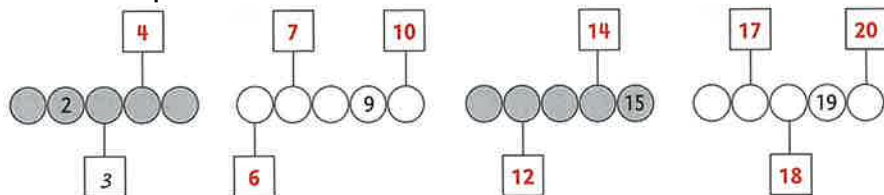

3

cua number ta pas?

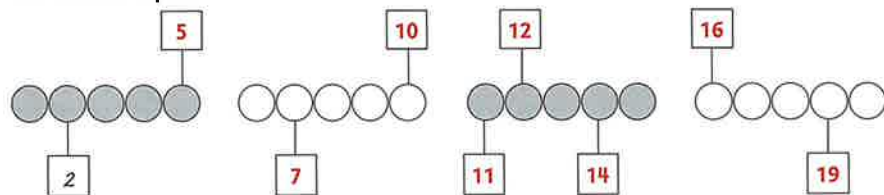

4

con abo ta sigui kleur?

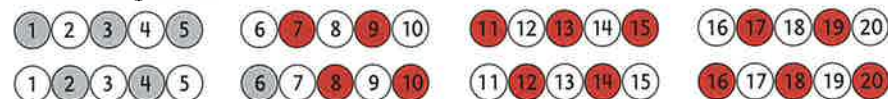

5

sigui conta.



6 conecta cu otro.

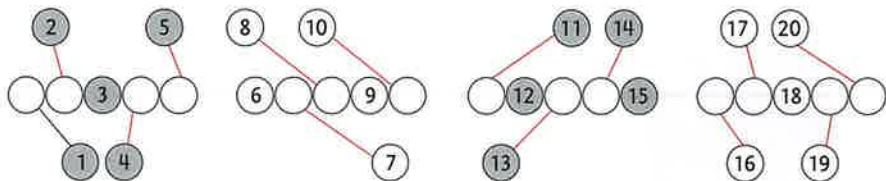

7 cua number ta pas?

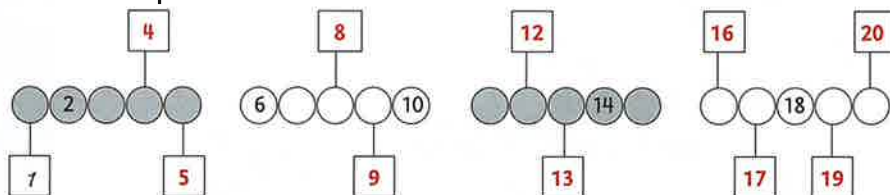
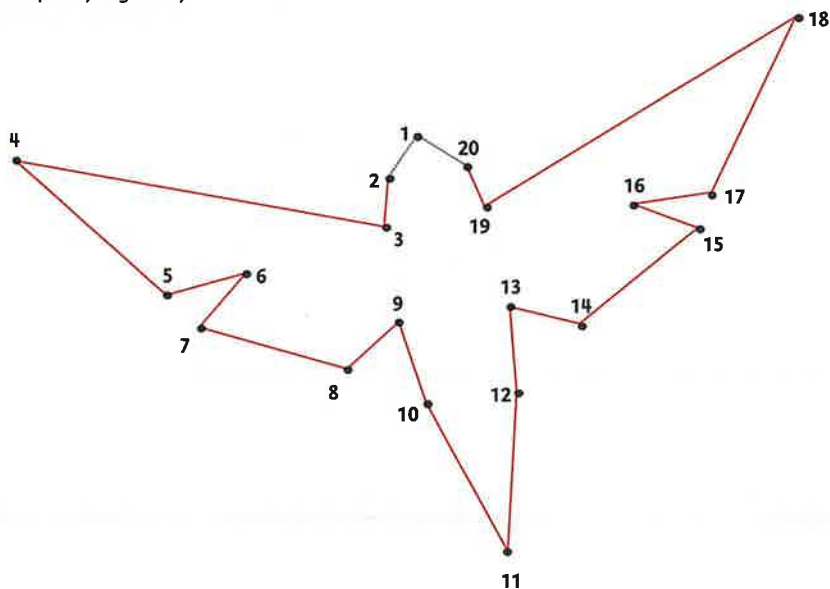
8 conecta e numbernan.
di 2 pa 3 y sigui bay.

1 kico rita y ricky ta haci?

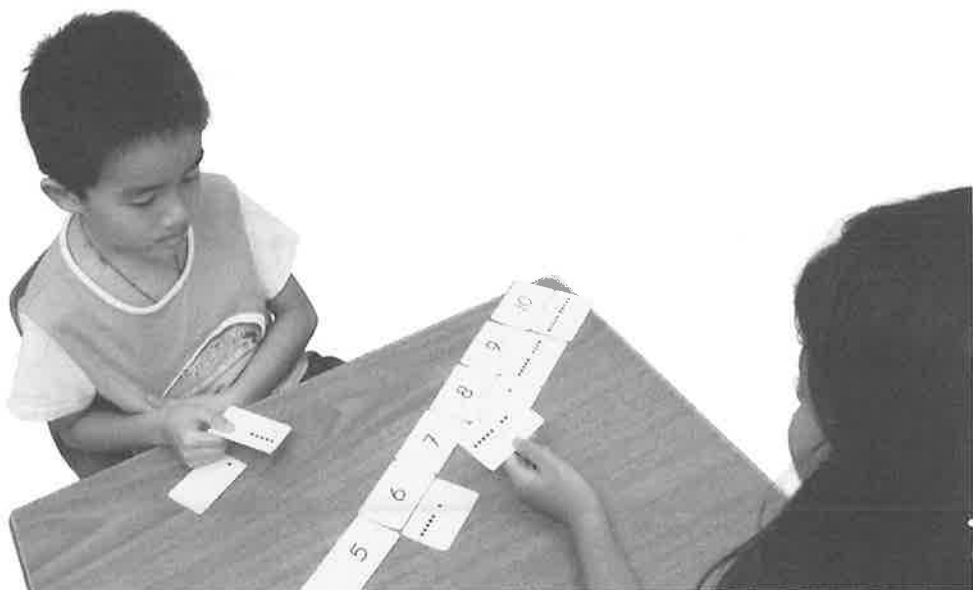

2 busca cua ta pas cu otro.



20

16

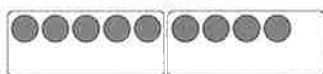

15

13



17

18

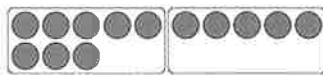

9

4



19

10

- 3 / **cuanto kinki tin hunto?**
mustra y conta.

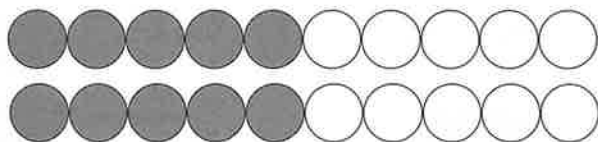

- 4 / **cua number falta?**

1 2 3 4 5 6 7 8 9 10 11 12 13 14 15 16 17 18 19 20

1 2 3

10 11 12

5 6 7

15 16 17

18 19 20

8 9 10

- 5 / **cuanto tin hunto?**

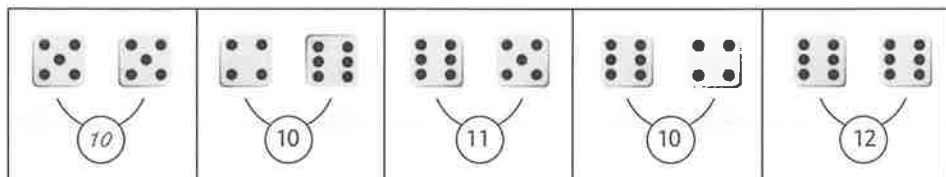

- 6 / **caba cu tur tarea den bo buki di conta.**

1 conecta cu otro.

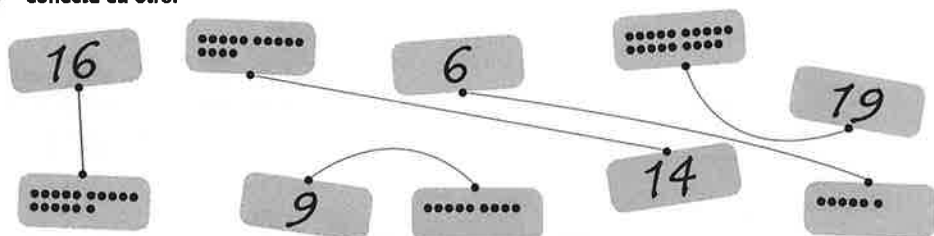

2 yena number y pinta ronchi.

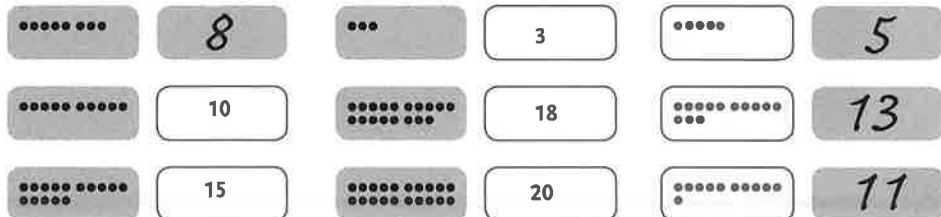

3 skirbi e numbernan.



4 conecta cu otro.

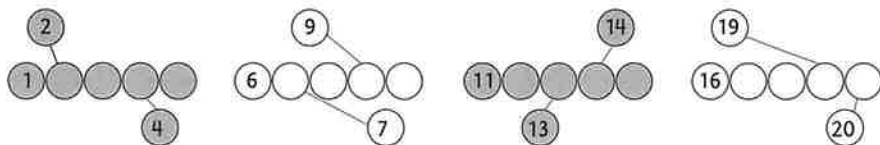

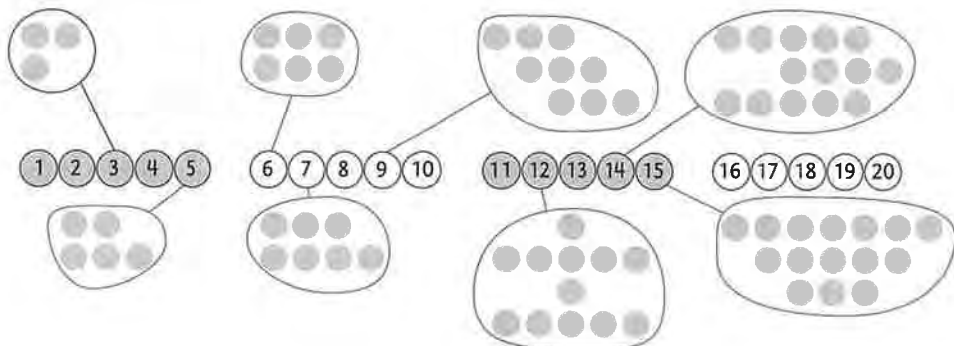
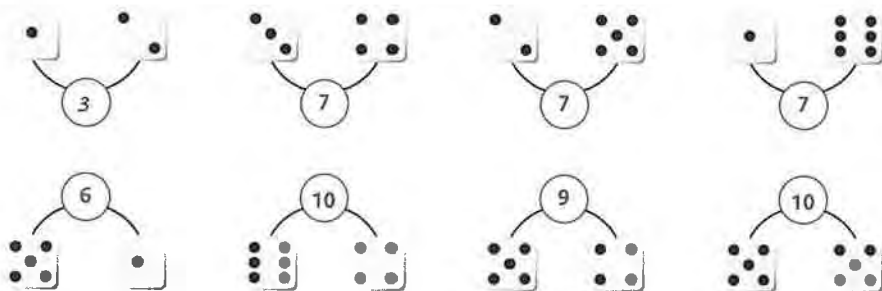
5 **conecta cu otro.**6 **cuanto tin hunto?**7 **pinta e wowonan.**8 **pinta e wowonan na diferente manera.**

30

blok 3

les 10 ripiti

1

cuanto pisca tin?



17 pisca

2

conecta cu otro.

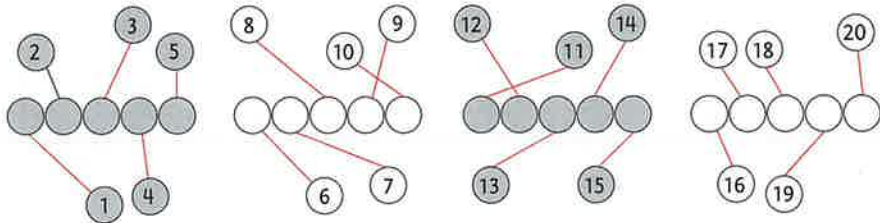

3

skirbi e numbernan.



4

kleur cada pasa un ronchi.

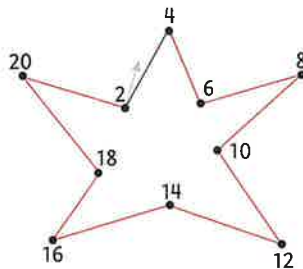

5

conecta e numbernan.
di 2 pa 4 y sigui bay.

- 1 **cua di nan ta mes hopi?**
conecta cu otro.



- 2 **hunto nan ta costa 12 florin.**
kleur nan. mas cu 1 contesta.

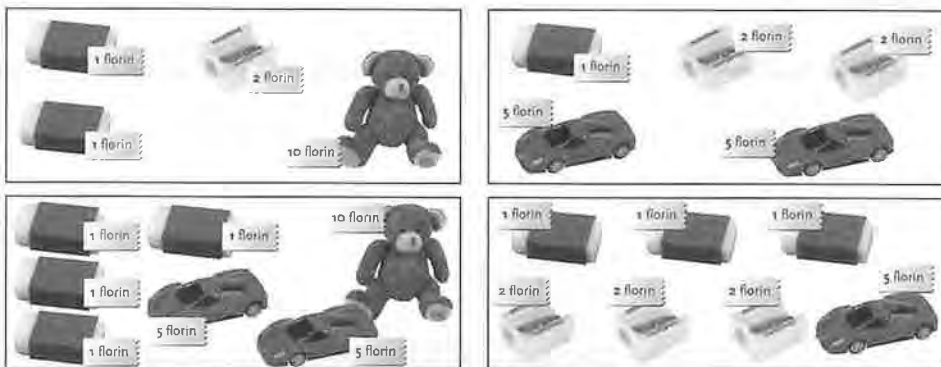

- 3 **completa 15 florin.**
pinta e placa. mas cu 1 contesta.

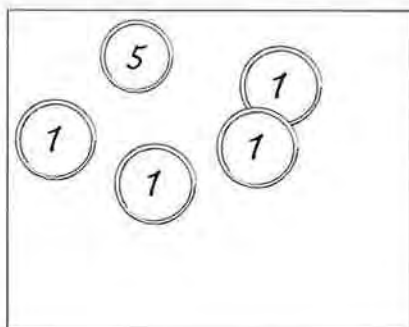
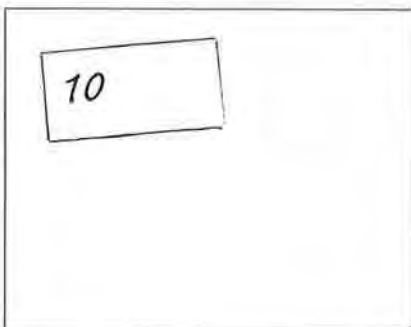

4 sigui conta.



5 split 10.
kleur e ronchinan y yena e numbernan.

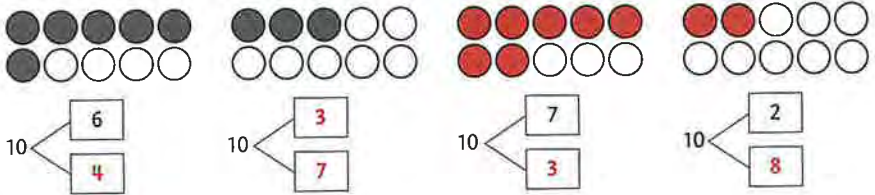

6 pensa pa bo mes.
kleur e ronchinan y yena e numbernan. **mas cu 1 contesta.**

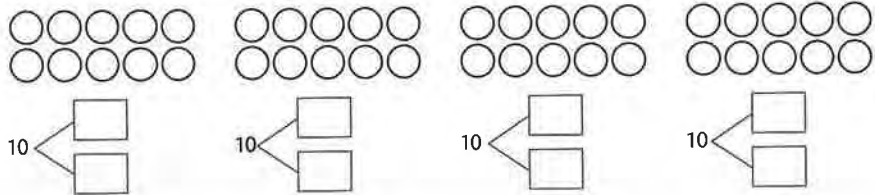

1 cerca y leu.



2 cada biahá mas cerca.

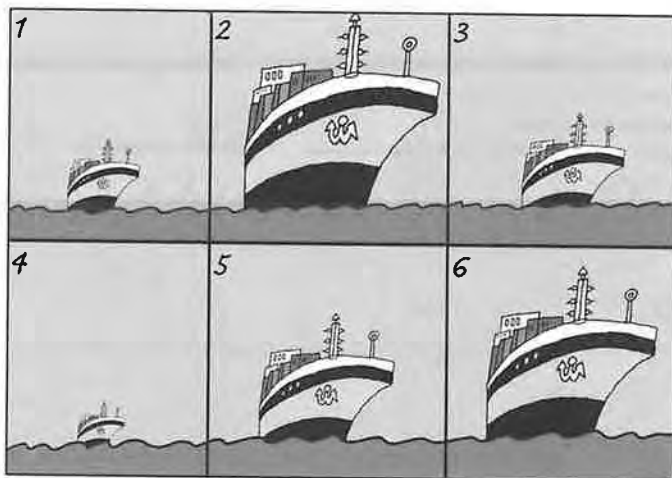

- 3 **pone e blokinan mescos.** 5
cuanto bloki bo ta uza?



- 4 **pone e blokinan mescos.**
cuanto bloki bo ta uza?

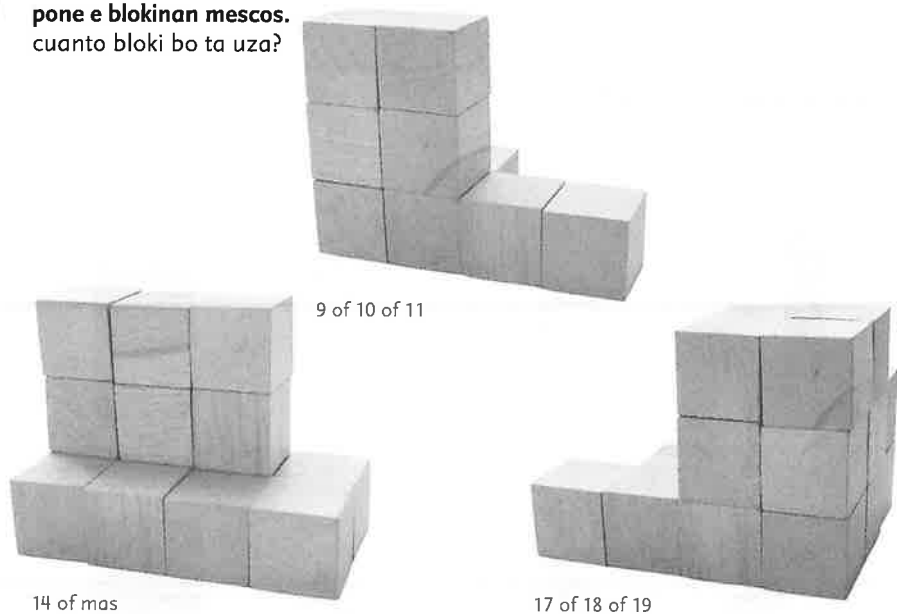

- 5 **traha cu 7 bloki.**
pone nan na diferente manera.

34

blok 3

les 14

1 kleur e bala cu ta mas cerca di e ronchi.

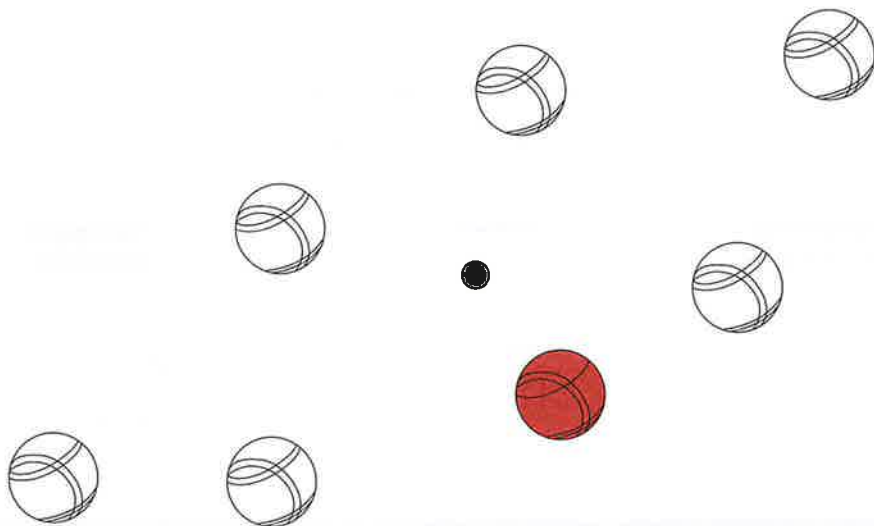
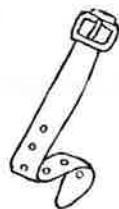
2 kleur esun cu ta mas largo cu bo.
mas cu 1 contesta.

3 *cua potlood ta mas cortico?*

skirbi 1 na e potlood mas cortico.
sigui asina.
di cortico bay largo.

2	6	4	7	1	5	8	3
---	---	---	---	---	---	---	---

4 *skirbi e numbernan.*

6 7 8	13 14 15	18 19 20
15 16 17	17 18 19	11 12 13
11 12 13	10 11 12	16 17 18
9 10 11	14 15 16	10 11 12

5 *cua number ta pas?*

--	--	--	--

36

blok 3

les 15 ripiti

1

kleur mes hopi.

haci esaki na diferente manera. mas cu 1 contesta.

12 florin	
12 florin	
12 florin	
12 florin	
12 florin	
12 florin	

2

cua di nan ta mes hopi?

conecta cu otro.



7 florin

12 florin

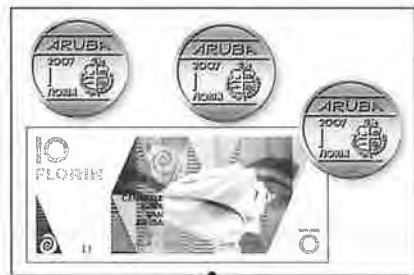

13 florin

18 florin



3 2 ora mas laat.
pinta e man chikito.

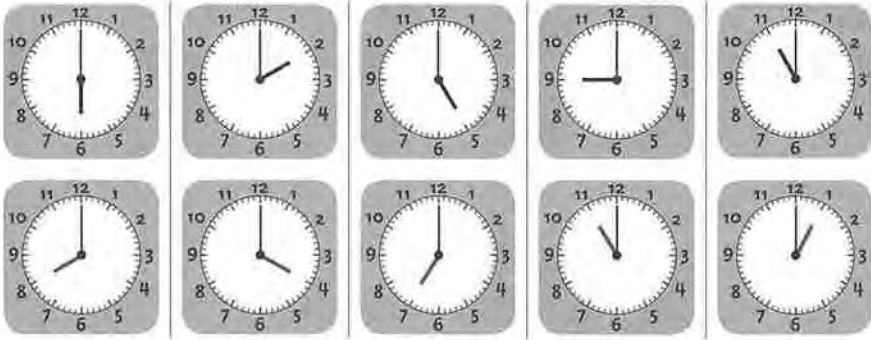

4 2 ora mas tempran.
pinta e man chikito.

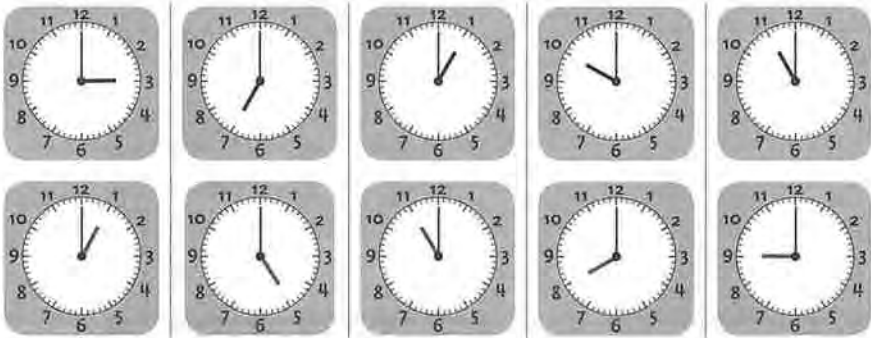

5 cuanto tin di cada sorto?
cuanto tin hunto?

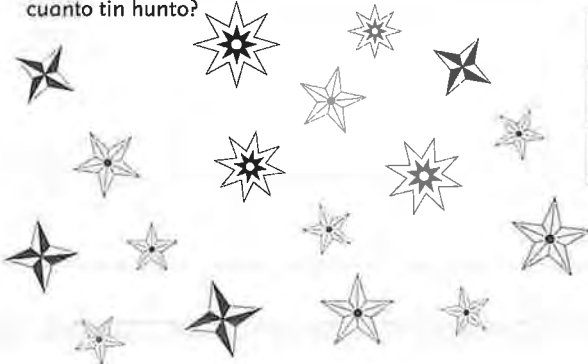

4 strea di 4 punta.

9 strea di 5 punta.

4 strea di 8 punta.

hunto tin 17 strea.

split.

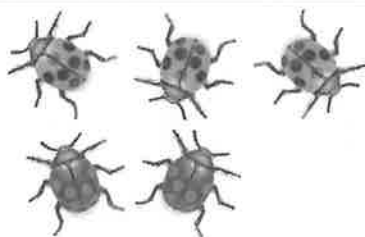
$$5 \begin{cases} 3 \\ 2 \end{cases}$$

$$3 + 2$$

$$7 \begin{cases} 6 \\ 1 \end{cases}$$



$$\begin{aligned} 7 + 0 \\ 6 + 1 \\ 5 + 2 \\ 4 + 3 \\ 3 + 4 \\ 2 + 5 \\ 1 + 6 \\ 0 + 7 \end{aligned}$$

2

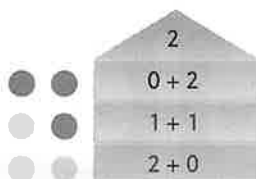
hotel di split.
hotel di split 2.

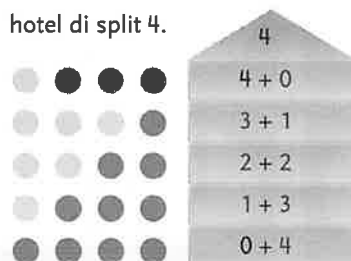

hotel di split 4.



hotel di split 5.

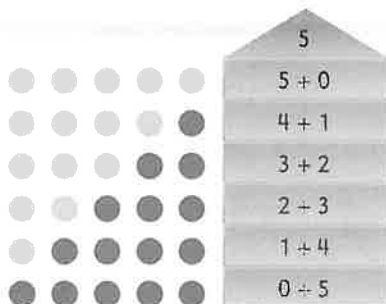

hotel di split 7.

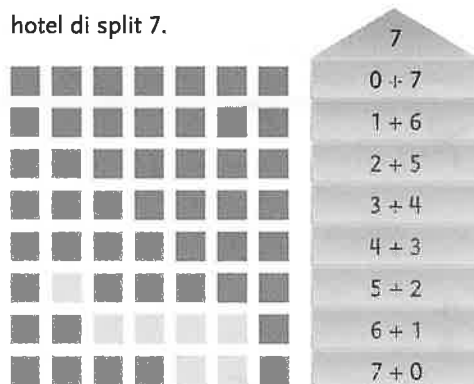

3 hotel di split 10.

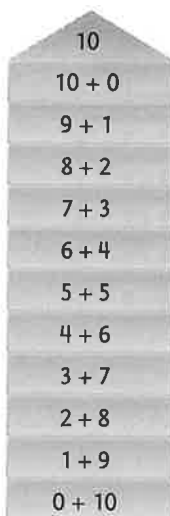
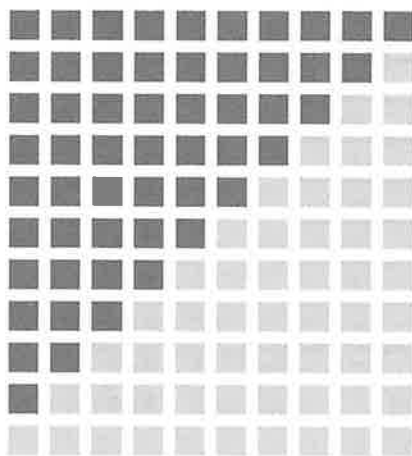
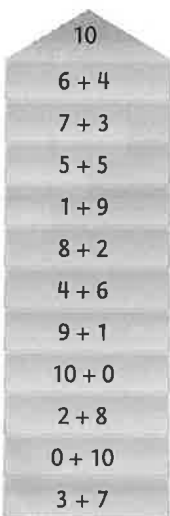
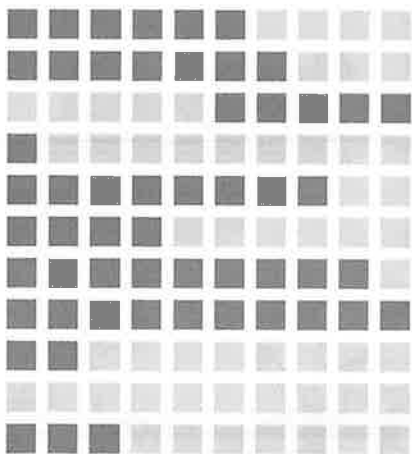
4 e mesun hotel di split 10.
pero kico ta diferente?5 split 6 y 9.
split na tur manera.

1 split.

4
$0 + 4$
$1 + 3$
$2 + 2$
$3 + 1$
$4 + 0$

5
$0 + 5$
$1 + 4$
$2 + 3$
$3 + 2$
$4 + 1$
$5 + 0$

8
$0 + 8$
$1 + 7$
$2 + 6$
$3 + 5$
$4 + 4$
$5 + 3$
$6 + 2$
$7 + 1$
$8 + 0$

9
$0 + 9$
$1 + 8$
$2 + 7$
$3 + 6$
$4 + 5$
$5 + 4$
$6 + 3$
$7 + 2$
$8 + 1$
$9 + 0$

2 split 6.
yena e numbernan y kleur e hokinan.

6
$0 + 6$
$1 + 5$
$2 + 4$
$3 + 3$
$4 + 2$
$5 + 1$
$6 + 0$

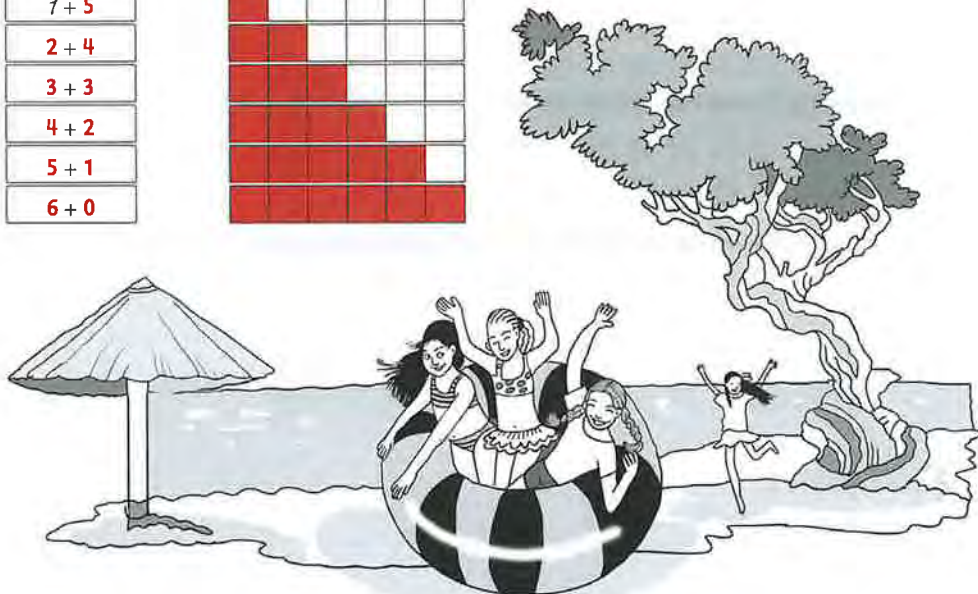
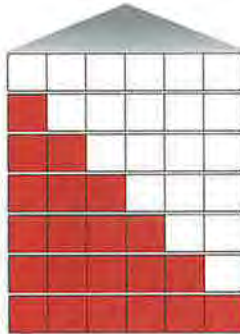

3

split 7.

yena e numbernan y kleur e hokinan.

7
$0 + 7$
$1 + 6$
$2 + 5$
$3 + 4$
$4 + 3$
$5 + 2$
$6 + 1$
$7 + 0$

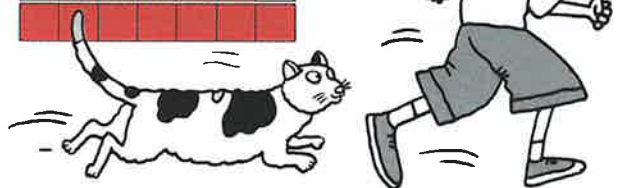
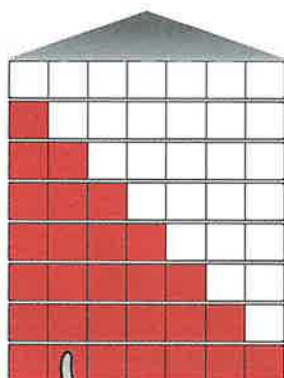

4

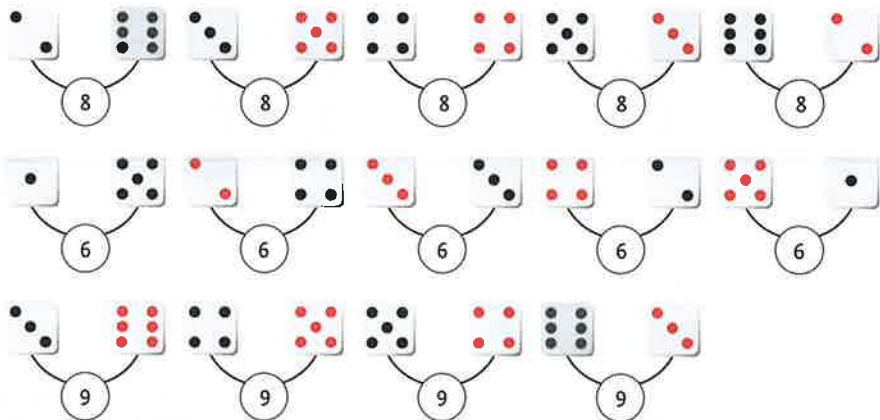
pinta e wowonan.

5

pensa pa bo mes. mas cu 1 contesta.

- 1 **cuanto nan ta costa?**
con bo ta paga?



8 florin



13 florin



17 florin



14 florin



20 florin

- 2 **pone na diferente manera.**



20 florin



20 florin

- 3 **pone na diferente manera.**



20 florin



20 florin

4 paga na diferente manera.



9 florin



10 florin



17 florin



12 florin

5 pone na diferente manera.



10 florin



10 florin

- 1 paga na diferente manera.
kleur e placa. mas cu 1 contesta.

10 florin	
10 florin	
13 florin	
13 florin	
15 florin	
15 florin	
20 florin	
20 florin	

- 2 kleur e hokinan cu tin:

5 florin



7 florin



13 florin

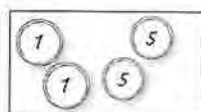

16 florin

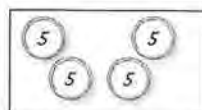
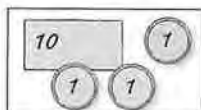
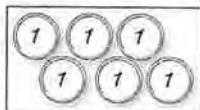
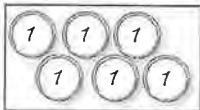
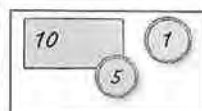
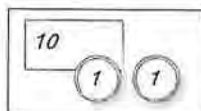
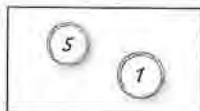
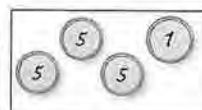
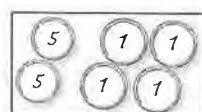

3 den cua cartera tin suficiente placa?
marca un cruz den e hoki.



16 florin

4 conecta cu otro.

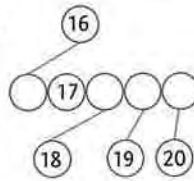
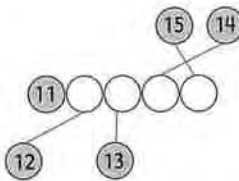
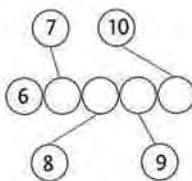
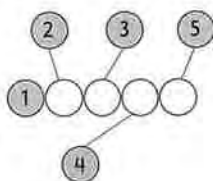

5 yena tur hotel di split.

5

$5 + 0$
$4 + 1$
$3 + 2$
$2 + 3$
$1 + 4$
$0 + 5$



2

$0 + 2$
$1 + 1$
$2 + 0$

3

$0 + 3$
$1 + 2$
$2 + 1$
$3 + 0$

4

$0 + 4$
$1 + 3$
$2 + 2$
$3 + 1$
$4 + 0$

6

$0 + 6$
$1 + 5$
$2 + 4$
$3 + 3$
$4 + 2$
$5 + 1$
$6 + 0$

7

$0 + 7$
$1 + 6$
$2 + 5$
$3 + 4$
$4 + 3$
$5 + 2$
$6 + 1$
$7 + 0$

8

$0 + 8$
$1 + 7$
$2 + 6$
$3 + 5$
$4 + 4$
$5 + 3$
$6 + 2$
$7 + 1$
$8 + 0$

9

$0 + 9$
$1 + 8$
$2 + 7$
$3 + 6$
$4 + 5$
$5 + 4$
$6 + 3$
$7 + 2$
$8 + 1$
$9 + 0$

1 split.

4	2	3	5	6	7
$0+4$	$0+2$	$0+3$	$5+0$	$6+0$	$7+0$
$1+3$	$1+1$	$1+2$	$4+1$	$5+1$	$6+1$
$2+2$	$2+0$	$2+1$	$3+2$	$4+2$	$5+2$
$3+1$		$3+0$	$2+3$	$3+3$	$4+3$
$4+0$			$1+4$	$2+4$	$3+4$
			$0+5$	$1+5$	$2+5$
				$0+6$	$1+6$
					$0+7$

2
cua ta mas caro?
kleur e.

9 florin



7 florin



4 florin

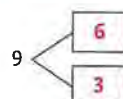
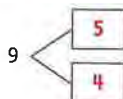
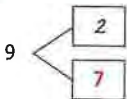

12 florin

3
con ta split aki?

4 skirbi e numbernan.

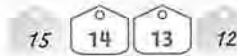
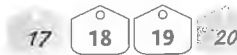
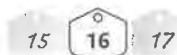

5 conecta cu otro.

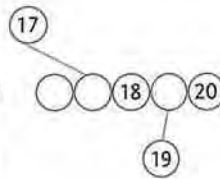
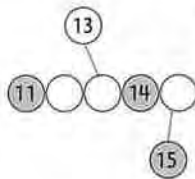
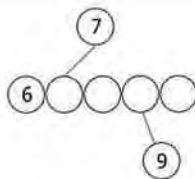
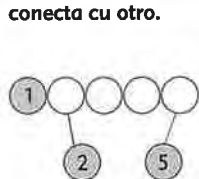

6 pinta e man chikito.



6 or



9 or



3 or



12 or



8 or



1 or



11 or



5 or



7 or



4 or

7 skirbi e numbernan di chikito bay grandi.

3	7	5	2	1
10	8	4	7	3
11	18	9	6	13
17	15	20	14	18

7	2	3	5	7
3	4	7	8	10
6	9	11	13	18
14	15	17	18	20



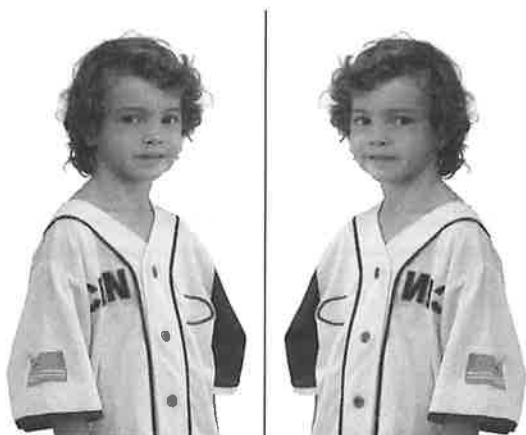

1 cuanto?

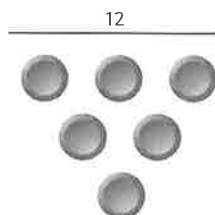
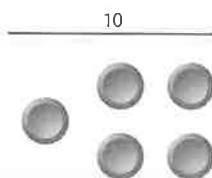
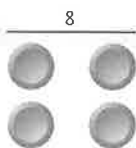
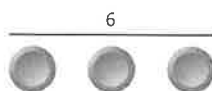

2 cuanto ficha tin?

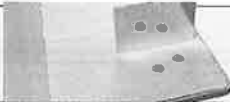

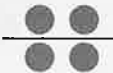
3 uza spiel pa haci dobel.

				
2			$2 + 2$	4
3			$3 + 3$	
4				
5				
6				

4 pone 8 ficha.

uza spiel pa haci nan dobel. 16
haci mescos cu 9 y 10 ficha. 18, 20

$$8 + 8 = 16$$

$$9 + 9 = 18$$

$$10 + 10 = 20$$

5 cuanto kiniki tin?

dany tin 5 kiniki.
anita tin dobel di esey.
cuanto kiniki anita tin? 10

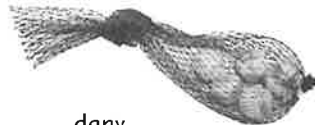

dany



anita

6 cuanto lollipop?

wina tin 6 lollipop.
e ta parti nan cu gibi.
tur dos ta haya mes hopi.
cuanto lollipop gibi ta haya? 3



1 uza spiel y pinta e ronchinan.

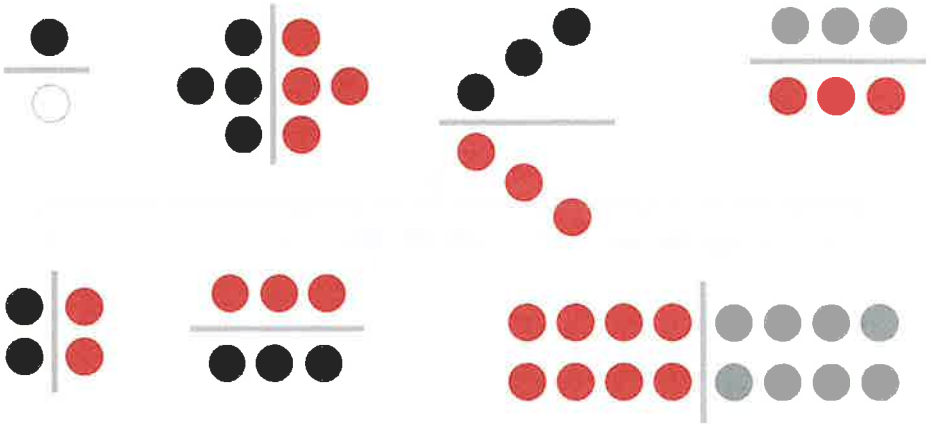

2 uza spiel y pinta e ronchinan.

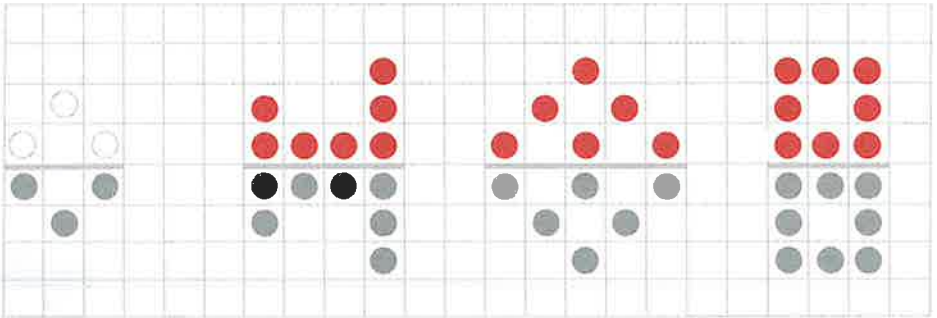

3 sigui na e mesun manera.
uza spiel pa controla.

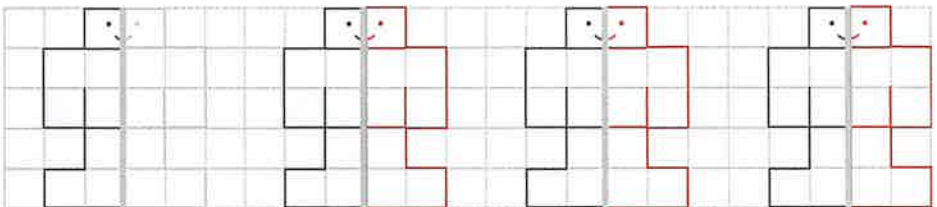

4

uza spiel pa haci dobel.
cua som bo mester traha aki?

2	○ ○	○ ○									
		○ ○								$2 + 2$	4
3	○ ○ ○	● ● ●									
		● ● ●								$3 + 3$	6
4	○ ○ ○ ○	● ● ● ●									
		● ● ● ●								$4 + 4$	8
5	○ ○ ○ ○ ○	● ● ● ● ●									
		● ● ● ● ●								$5 + 5$	10
6	○ ○ ○ ○ ○ ○	● ● ● ● ● ●									
		● ● ● ● ● ●								$6 + 6$	12
7	○ ○ ○ ○ ○ ○ ○	● ● ● ● ● ● ●									
		● ● ● ● ● ● ●								$7 + 7$	14
8	○ ○ ○ ○ ○ ○ ○ ○	● ● ● ● ● ● ● ●									
		● ● ● ● ● ● ● ●								$8 + 8$	16
9	○ ○ ○ ○ ○ ○ ○ ○ ○	● ● ● ● ● ● ● ● ●									
		● ● ● ● ● ● ● ● ●								$9 + 9$	18

5

yena e dobel.

2	
2	4

3	6
3	

4	8
4	

5	10
5	

6	12
6	

7	14
7	

8	16
8	

9	18
9	

10	20
10	

6

split 8.
cuanto tin bou di e pechi?

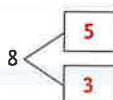
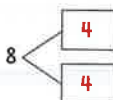
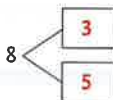
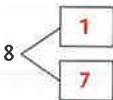

1 midi cu e liniaal di cralchi.



2 midi cu e liniaal di cralchi.

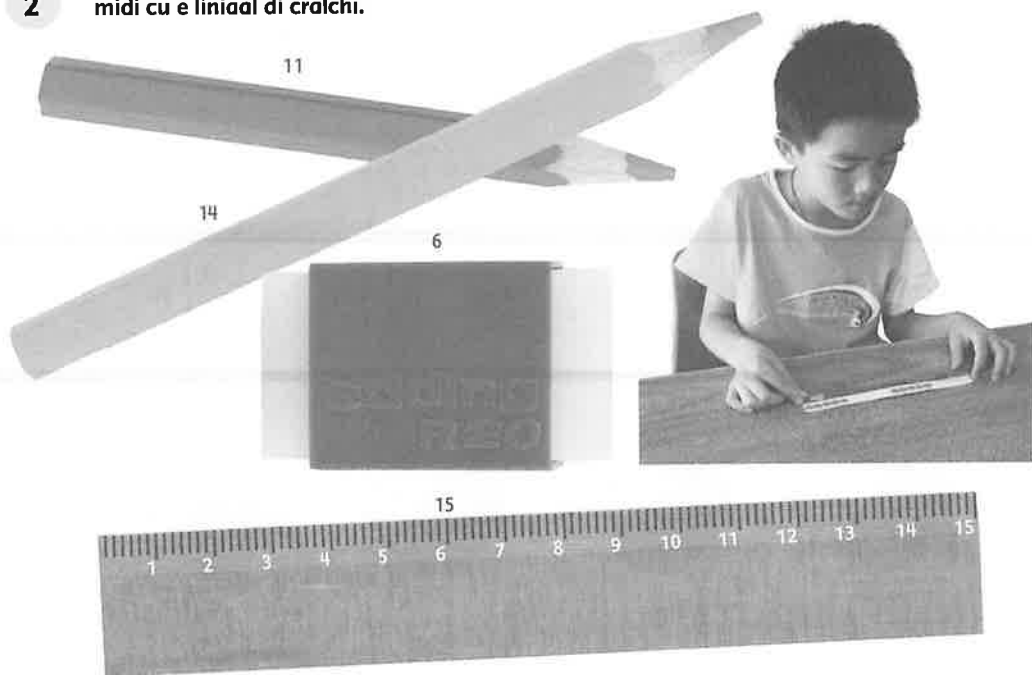

3 con largo nan ta?

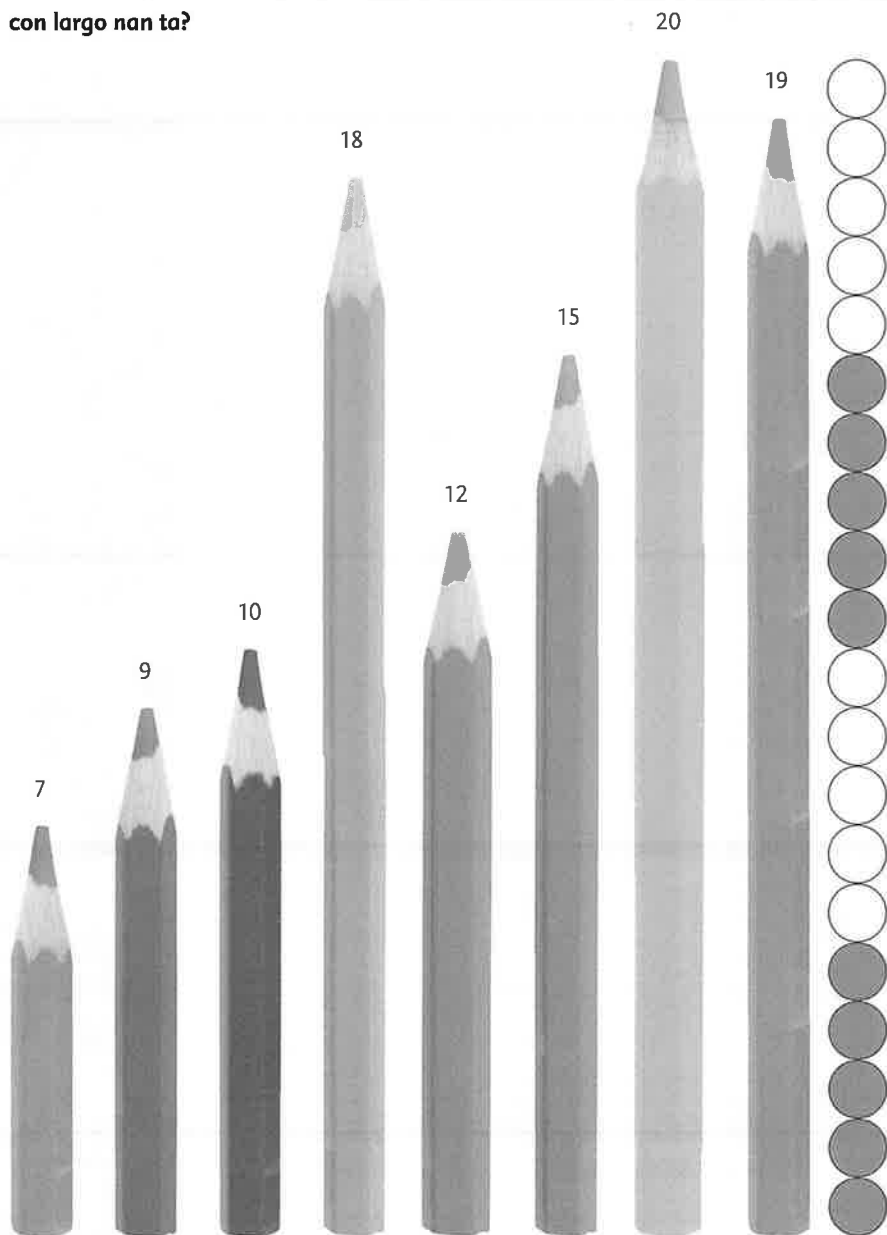

4 abo mes pinta un potlood di 16.

1 kleur e banchinan.

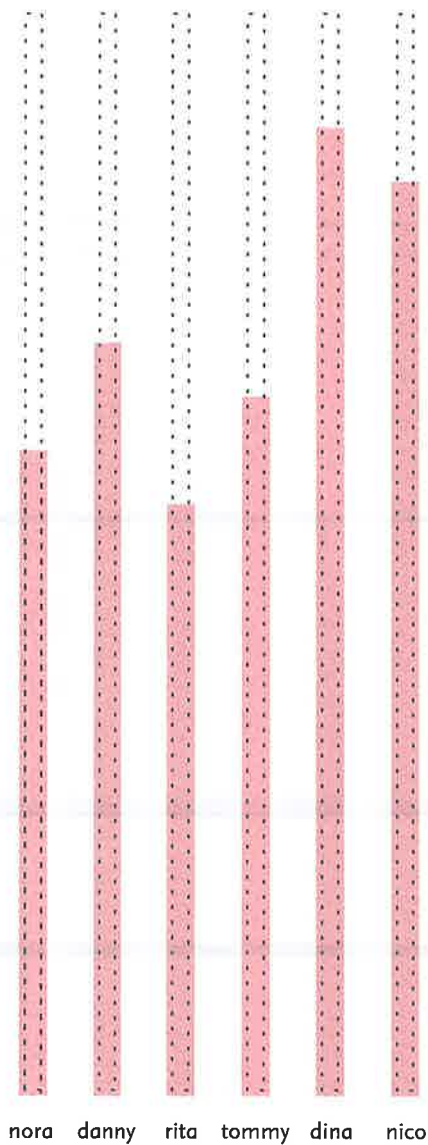

nora 12



danny 14



rita 11



tommy 13



dina 18



nico 17



2 conecta cu otro.

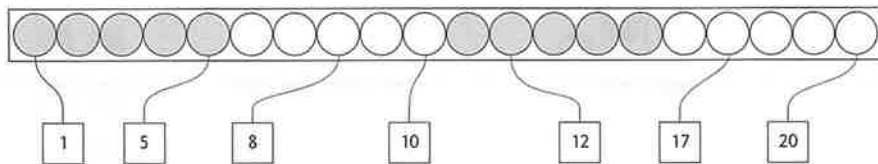

3 midi e strawnan.

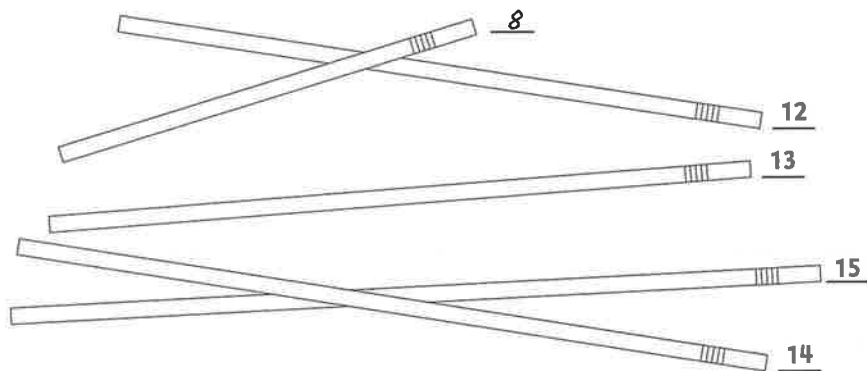

4 conta di 1 te 20.
skirbi e numbranan.



5 salta 1 cada biaha.
skirbi e numbranan.



1 uza spiel y pinta.

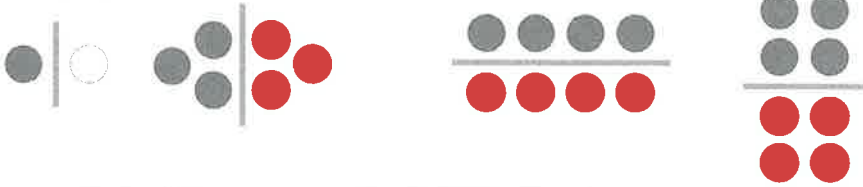

2 uza spiel y pinta.

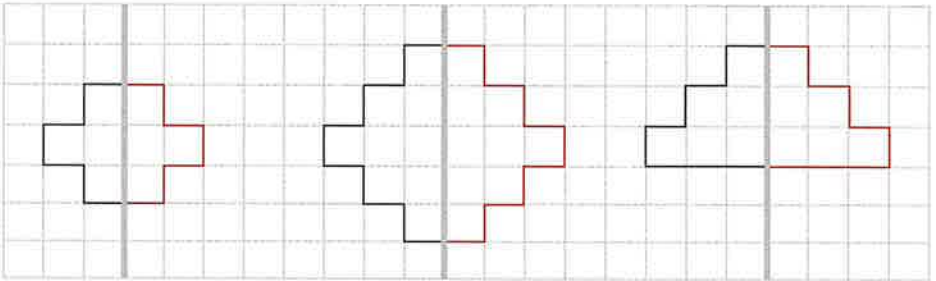

3 mes hopi.

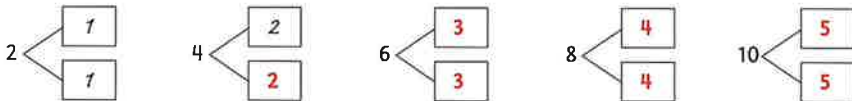

4 yena dobel di e number.

number	4	2	5	1	6	3	8	10	7	9
dobel	8	4	10	2	12	6	16	20	14	18

5 cuanto tin hunto?



6 skirbi e numbernan.



7 split 10.
yena e numbernan y kleur e hokinan.

10
0 + 10
1 + 9
2 + 8
3 + 7
4 + 6
5 + 5
6 + 4
7 + 3
8 + 2
9 + 1
10 + 0

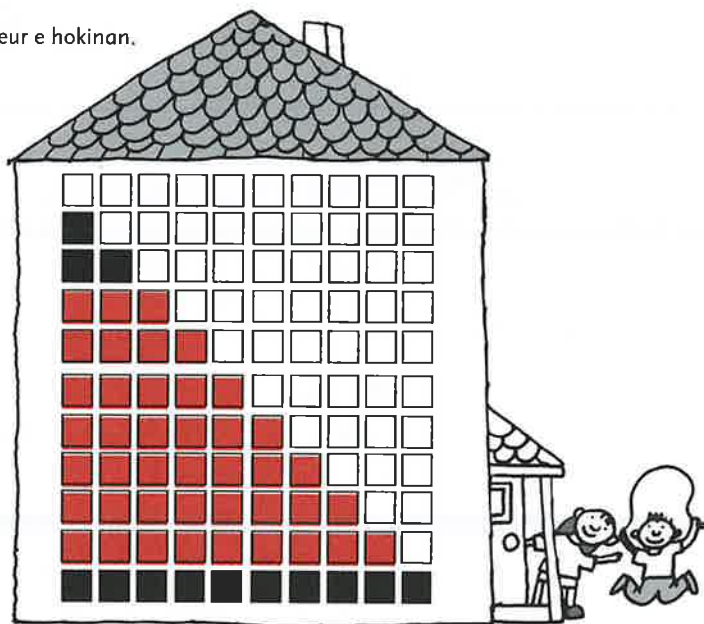

8 pensa pa bo mes.

mas cu 1 contesta.

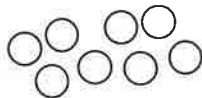

$$\square + \square$$

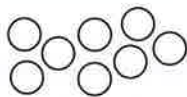

$$\square + \square$$

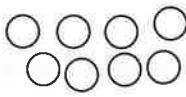

$$\square + \square$$

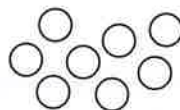

$$\square + \square$$

50

blok 3

den uno rato

1

cuanto tin di cada un?

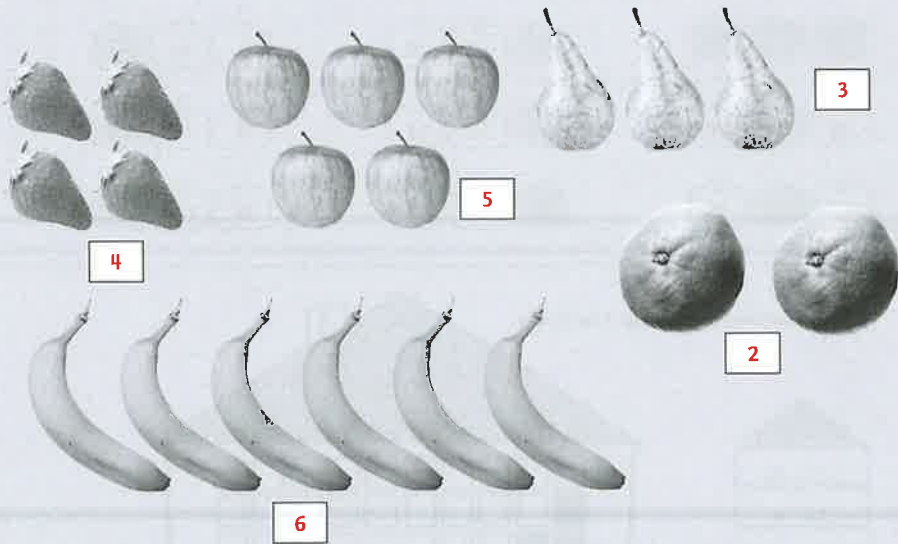

2

con bo ta sigui kleur?



3

skirbi e numbernan.

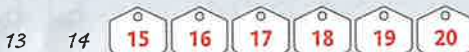
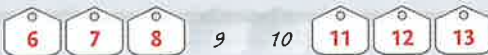

4 split 6.

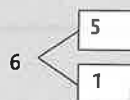
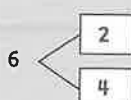
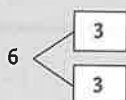
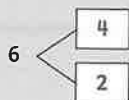
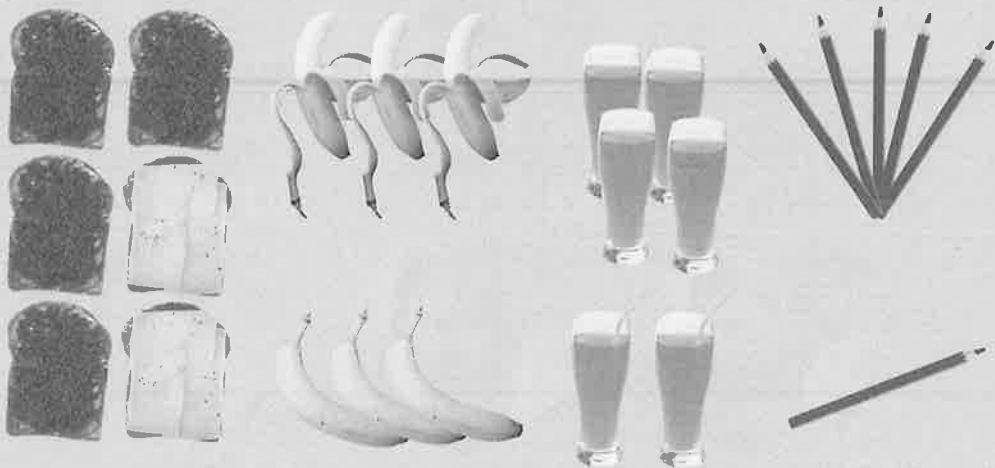

5 conecta cu otro.

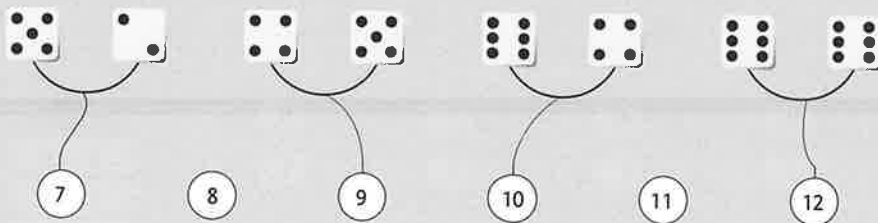

6 cuanto tin di cada un?



4



5



6



6



7

7 cuanto florin tin?

a florinb florinc florind florine florinf florin

8 split.

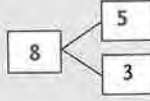
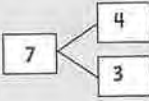
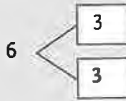
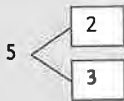
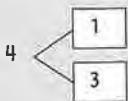

9 split 10.

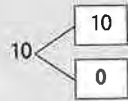
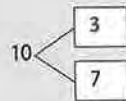
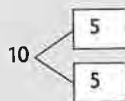
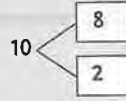
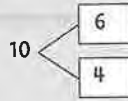
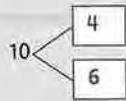
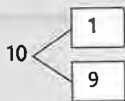
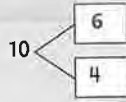
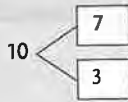
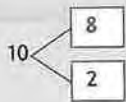
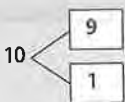

10
0 + 10
1 + 9
2 + 8
3 + 7
4 + 6
5 + 5
6 + 4
7 + 3
8 + 2
9 + 1
10 + 0

10 **cuant'or tin?**



2 or



4 or



12 or



10 or



8 or

11 **cuant'or tin?**



5 or



7 or



9 or



3 or



6 or

12 **conta cralchi.**

pinta un strepi tras di e cantidad corecto.



10



15



8



17



14



4



16



18

13 **cuanto tin di cada un?**



8



9



10

54

blok 3

dal bay

- 1 **kleur cada biahu 5.**
despues traha grupo di 10.
cuanto ronchi tin hunto?

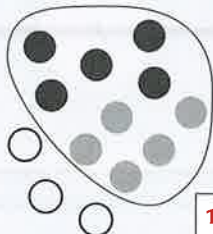

13

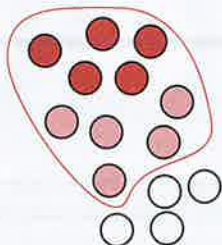

14

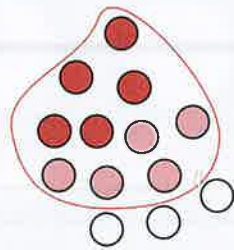

13

- 2 **cuanto tin?**

kleur mes hopi.

skirbi.

		18
		20
		17
		16
		19

- 3 **pinta e wowonan. mas cu 1 contesta.**

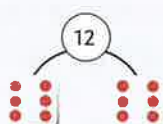
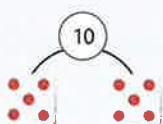
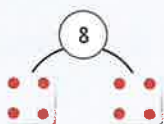
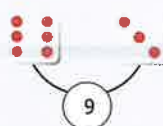
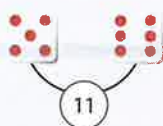

- 4 **busca e ruta.**
conta di 1 te 20.

1	2	15	18	16	14	10	12
4	3	12	7	8	9	6	8
5	2	18	10	11	5	2	4
6	7	8	9	12	14	9	18
2	12	11	7	13	1	12	20
9	13	14	10	14	15	4	19
6	5	3	11	12	16	17	18

conta bay bek di 20 te 1.

6	5	4	10	12	15	16	17
8	2	3	1	13	14	11	18
12	7	8	5	12	13	12	19
14	6	9	10	11	16	17	20
16	5	4	7	4	3	15	19
1	2	3	6	9	5	13	14
1	2	12	2	12	8	7	12

- 5 **cua number ta pas?**

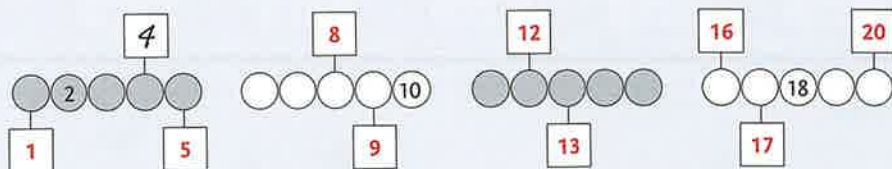

- 6 **kleur cada pasa un ronchi.**
conecta e numbranan cu otro.

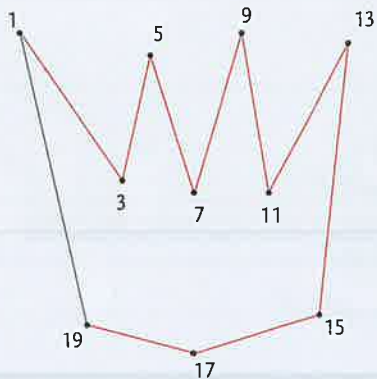

56

blok 3

dal bay

7

split 7.

kleur e ronchinan y yena number.



$$2 + 5$$



$$5 + 2$$



$$3 + 4$$



$$4 + 3$$



$$6 + 1$$

8

split 9.

kleur e ronchinan y yena number.

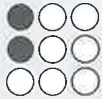

$$2 + 7$$

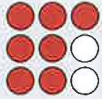

$$7 + 2$$



$$3 + 6$$



$$6 + 3$$

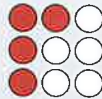

$$4 + 5$$

9

split 6.



$$2 + 4$$

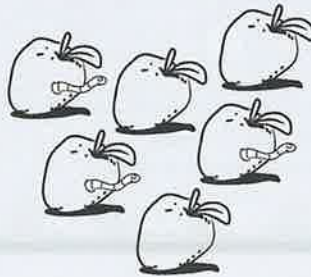

$$3 + 3$$

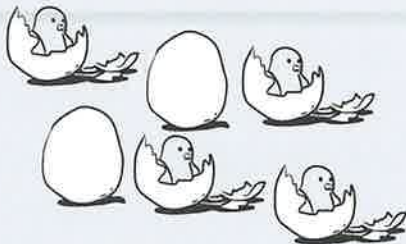

$$4 + 2$$

of 2 + 4



$$5 + 1$$

of 1 + 5

- 10** split 6.
kleur e ronchinan y yena number.



$7 + 5$



$5 + 1$



$2 + 4$



$4 + 2$



$3 + 3$

- 11** pinta e man chikto.



9 or



3 or



5 or



7 or



1 or



8 or



4 or



2 or



10 or



6 or

- 12** cuanto nan ta costa hunto?



6 florin



7 florin



10 florin



13 florin



16 florin



17 florin

1

cuanto tin di cada un?



22

tin suficiente straw?
kleur si of no.

si

no



24

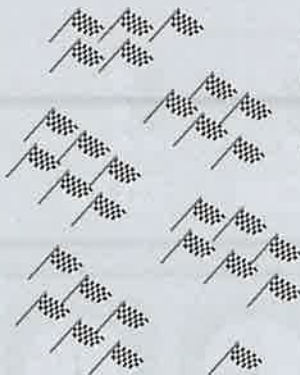

29

tin suficiente banderín?
kleur si of no.

si

no



27

2

split.

14
$0 + 14$
$1 + 13$
$2 + 12$
$3 + 11$
$4 + 10$
$5 + 9$
$6 + 8$
$7 + 7$
$8 + 6$
$9 + 5$
$10 + 4$
$11 + 3$
$12 + 2$
$13 + 1$
$14 + 0$

15
$0 + 15$
$1 + 14$
$2 + 13$
$3 + 12$
$4 + 11$
$5 + 10$
$6 + 9$
$7 + 8$
$8 + 7$
$9 + 6$
$10 + 5$
$11 + 4$
$12 + 3$
$13 + 2$
$14 + 1$
$15 + 0$

13
$0 + 13$
$1 + 12$
$2 + 11$
$3 + 10$
$4 + 9$
$5 + 8$
$6 + 7$
$7 + 6$
$8 + 5$
$9 + 4$
$10 + 3$
$11 + 2$
$12 + 1$
$13 + 0$

- 3 con ta split aki?
ken ta gana?
kleur e macutu.

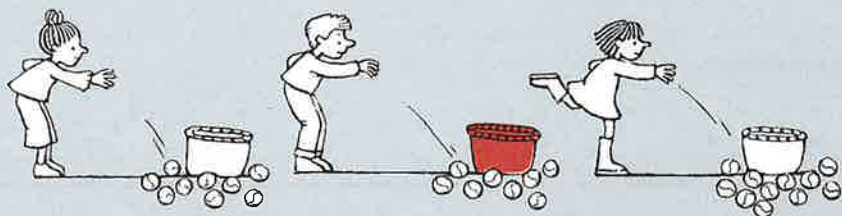
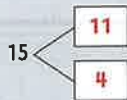
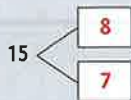
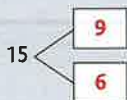

- 4 con ta split aki?
ken ta gana?
kleur e macutu.

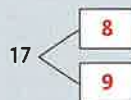

- 5 a conecta cu otro.

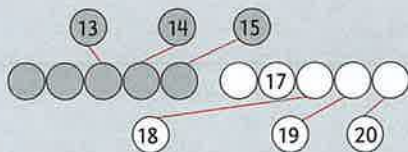

- b cua number ta pas?

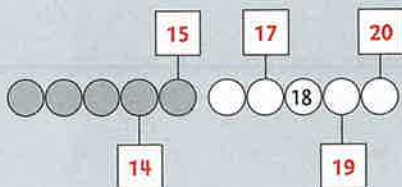

6

cuanto tin hunto?

5	3	7	2	7	1	1	8	2	7	4	5
8		9		8		9		9		9	
6	6	6	7	7	8	9	5	8	4	9	7
12		13		15		14		12		16	

7

cuanto tin hunto?

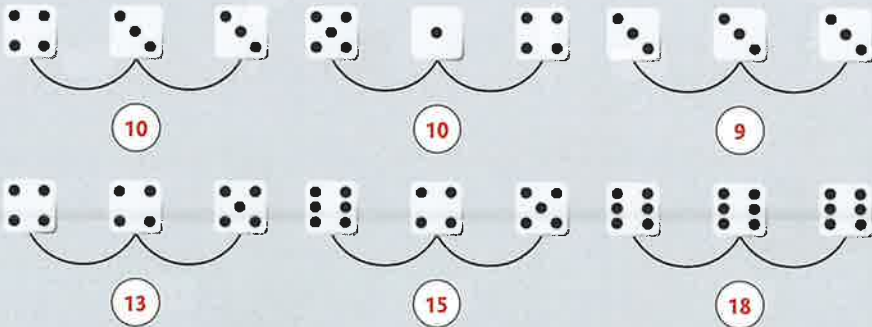

8

cuanto curason tin riba henter e bolo?

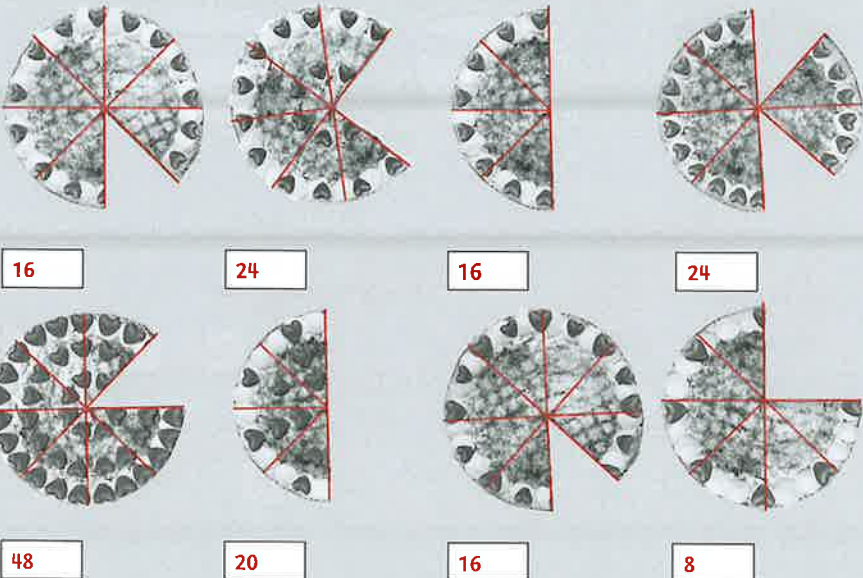

9 completa e rijnan. mas cu 1 contesta.

conta cu salto di 3.

1	4	7	10	13	16	19	22	25	28
---	---	---	----	----	----	----	----	----	----

conta bay bek cu salto di 3.

30	27	24	21	18	15	12	9	6	3
----	----	----	----	----	----	----	---	---	---

pensa pa bo mes.

--	--	--	--	--	--	--	--	--	--

10 conta di 1 te 27.

27	26	1	11	10	3	1	6
2	25	3	6	8	4	2	3
23	24	4	4	2	6	5	4
22	21	20	6	8	7	8	2
12	8	19	6	9	10	5	3
4	9	18	7	11	11	2	1
3	7	17	16	13	12	10	2
8	5	6	15	14	13	11	3
18	19	20	21	24	27	5	4



11 conta bay bek di 30 te 1.

28	30	27	19	18	17	7	8	5	2	3	1	8	9	10	11
24	29	23	21	20	19	4	10	4	1	5	4	3	12	13	14
12	28	31	22	16	18	17	13	2	8	7	6	5	20	19	4
24	27	26	23	30	14	16	15	10	9	4	3	4	3	2	1
26	23	25	24	29	27	23	14	13	10	10	8	7	5	3	4
30	14	12	13	24	25	21	19	12	11	9	7	6	5	4	3
24	28	22	24	28	27	23	22	21	18	16	14	12	10	8	1
25	23	22	21	19	18	17	16	15	14	13	12	11	8	7	5

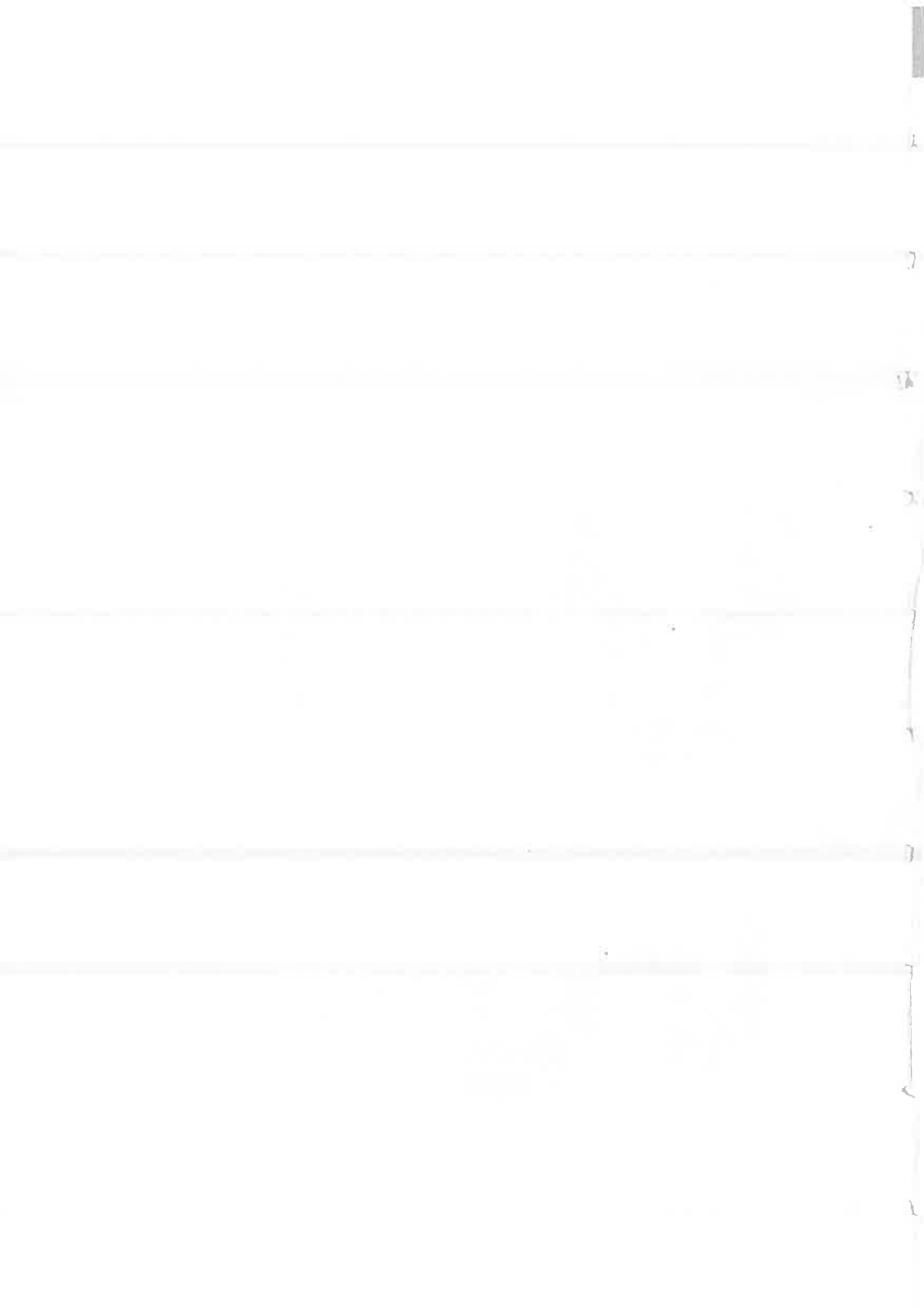

Conta cu mi

Metodo di matematica pa enseñansa primario

Alles telt

Reken-wiskundemethode voor het basisonderwijs

Traduccion y adaptacion

Grupo Matematica
Ovito Tromp
Barbara Meaux- O' Connor
Walter de Vet
Garrick Thodé
Berthson Boekhoudt

Redaccion

Seccion Desaroyo di Curiculo

Diseño

Criterium, Arnhem

Diseño grafico

GrafiData, Deventer

Diseño grafico

LaVerbe, Nijmegen

Realisacion

Paul Dijkstra
Wietske Linthorst-Dijkstra

Fotografia / Fotografie

Prince Victor

Ilustracion / Illustraties

Anka Kresse
LaVerbe, Nijmegen
Anjo Mutsaars

ISBN: 978-99904-1-264-2

Prome imprenta, prome edicion

© Departamento di Enseñansa di Aruba 2011

Auteurs

Els van den Bosch-Ploegh
Brugt Krol
Jeannette Nijs-van Noort
Ad Plomp
Wim Smeets
Anne Coos Vuurmans

Redactie

Broodtekst redactie, Utrecht
Marieke van Osch
Fundamenteel, Culemborg

Ontwerp

Criterium, Arnhem

Opmaak

GrafiData, Deventer

Vormgeving en beeldverwerking

LaVerbe, Nijmegen

ISBN: 978-90-06-63191-3

© ThiemeMeulenhoff, Amersfoort

E cas editorial a trata di regla derecho di autor conforme stipulacion di ley. No obstante esaki, si ainda tin cualkier persona di opinion cu nan por aserta cierto derecho, nan por dirigi nan mes na e cas editorial. ThiemeMeulenhoff ta desaroya material didactico pa enseñansa primario, enseñansa secundario general, enseñansa profesional, enseñansa di adulto y enseñansa superior profesional. Pa mas informacion tocante ThiemeMeulenhoff y un bista general di nos material educativo: www.thiememeulenhoff.nl

Tur derecho reserva.

Ta prohibi pa reproduci, download y/of publica, e edicion aki of parti di dje na ningun forma of medio, ni cu ta electronico, mecanico, fotocopia of di transmision, sin previa autorisacion por escrito di e cas editorial.

Tin caso specifico cu ta permiti pa haci copia for di e edicion aki, a base di articulo 16B di Auteurswet 1912 jo het Besluit van 20 juni 1974, Stb. 351, manera cambia den e Besluit van 23 augustus 1985, Stb. 471 y articulo Auteurswet 1912, por cumpli previamente cu e exigencianan legal di compensacion na Stichting Publicatie en Reprochten Organisatie (PRO), Postbus 3060, 2130 KB Hoofddorp (www.stichting-pro.nl)

Conta cu mi



Departamento di Enseñansa di Aruba

ISSN 978-99904-1-264-2